

M3B

Vital Signs Monitor

Version 2.4

User Manual

CE₀₁₂₃

EDAN

About this Manual

P/N: 01.54.109451

MPN: 01.54.109451024

Release Date: January 2019

© Copyright EDAN INSTRUMENTS, INC. 2008-2019. All rights reserved.

Statement

This manual will help you understand the operation and maintenance of the product better. It is reminded that the product shall be used strictly complying with this manual. User's operation failing to comply with this manual may result in malfunction or accident for which EDAN INSTRUMENTS, INC. (hereinafter called EDAN) cannot be held liable.

EDAN owns the copyrights of this manual. Without prior written consent of EDAN, any materials contained in this manual shall not be photocopied, reproduced or translated into other languages.

Materials protected by the copyright law, including but not limited to confidential information such as technical information and patent information are contained in this manual, the user shall not disclose such information to any irrelevant third party.

The user shall understand that nothing in this manual grants him, expressly or implicitly, any right or license to use any of the intellectual properties of EDAN.

EDAN holds the rights to modify, update, and ultimately explain this manual.

Responsibility of the Manufacturer

EDAN only considers itself responsible for any effect on safety, reliability and performance of the equipment if:

Assembly operations, extensions, re-adjustments, modifications or repairs are carried out by persons authorized by EDAN, and

The electrical installation of the relevant room complies with national standards, and

The instrument is used in accordance with the instructions for use.

Terms Used in this Manual

This guide is designed to give key concepts on safety precautions.

WARNING

A **WARNING** label advises against certain actions or situations that could result in personal injury or death.

CAUTION

A **CAUTION** label advises against actions or situations that could damage equipment, produce inaccurate data, or invalidate a procedure.

NOTE

A **NOTE** provides useful information regarding a function or a procedure.

Table of Contents

Chapter 1 Intended Use and Safety Guidance	1
1.1 Intended Use/Indications for Use.....	1
1.2 Safety Guidance	1
1.2.1 Environment.....	1
1.2.2 Power Source Requirements	1
1.2.3 Grounding the Monitor	1
1.2.4 Equipotential Grounding.....	2
1.2.5 Condensation.....	2
1.2.6 Safety Precautions.....	2
1.2.7 Protecting Personal Information	7
1.2.8 Explanation of Symbols on the Monitor	8
Chapter 2 Installation of Monitor	11
2.1 Opening the Package and Checking.....	11
2.2 Connecting the Power Cable.....	11
2.3 Powering on the Monitor	11
2.4 Connecting Sensor to Patient	12
2.5 Checking the Recorder.....	12
Chapter 3 Introduction.....	13
3.1 General Information	13
3.2 Screen Display	14
3.3 Button Functions	18
3.4 Interfaces	20
3.5 Built-in Rechargeable Battery.....	22
Chapter 4 System Menu	24
4.1 Patient Setup	24
4.2 Default Setup.....	24
4.3 System Setup.....	24
4.4 Selection.....	25
4.5 Deleting Data	25
4.6 Version.....	25
4.7 Time Setup	25
4.8 CO ₂ Setup.....	25
4.8 Alarm Setup.....	26
4.9 Maintain	26
4.10 Data Store.....	29
4.11 Sleep Mode.....	30
Chapter 5 Alarm	31
5.1 Alarm Modes.....	31

5.1.1 Alarm Level.....	31
5.1.2 Alarm Modes.....	31
5.1.3 Alarm Setup.....	33
5.2 Alarm Cause.....	34
5.3 Audio Alarm Paused.....	34
5.4 Audio Alarm Off.....	34
5.5 Alarm Reset.....	35
5.6 Parameter Alarm.....	35
5.7 When an Alarm Occurs.....	36
5.8 Testing Alarms.....	36
Chapter 6 Trend and Recording.....	37
6.1 General Information on Recording.....	37
6.2 Recorder Operations.....	37
6.3 Recorder Alarm Information.....	38
Chapter 7 Maintenance/Cleaning.....	39
7.1 Inspecting.....	39
7.2 Maintenance Task and Test Schedule.....	39
7.3 Cleaning.....	40
7.3.1 Cleaning the Monitor.....	40
7.3.2 Cleaning the Reusable Accessories.....	40
7.4 Disinfection.....	41
7.4.1 Disinfecting the Monitor.....	41
7.4.2 Disinfecting the Reusable Accessories.....	42
7.5 Cleaning and Disinfecting Other Accessories.....	42
7.6 Replacement of Fuse.....	42
7.7 Cleaning Battery and Battery Compartment Cover.....	42
Chapter 8 SpO₂ Monitoring.....	43
8.1 Overview.....	43
8.2 SpO ₂ Safety Information.....	43
8.3 Measuring SpO ₂	44
8.4 Measurement Limitations.....	45
8.5 Assessing the Validity of a SpO ₂ Reading.....	46
8.6 SpO ₂ Alarm Delay.....	47
8.7 Perfusion Index (PI)*.....	47
8.8 SatSeconds Alarm Management*.....	47
8.8.1 Describing SatSeconds.....	47
8.8.2 SatSeconds “Safety Net”.....	49
8.8.3 Setting SatSeconds Duration.....	49
8.9 Alarm Setup Menu.....	49
8.10 Alarm Description.....	50
Chapter 9 CO₂ Monitoring.....	52

9.1 Overview	52
9.2 CO ₂ Safety Information.....	52
9.3 Monitoring Procedures.....	53
9.3.1 Zeroing the Sensor	53
9.3.2 Sidestream CO ₂ Module.....	54
9.3.3 Mainstream CO ₂ Module	55
9.4 CO ₂ Setup Menu	57
9.4.1 CO ₂ Setup.....	57
9.4.2 CO ₂ Alarm Setup.....	58
9.4.3 Adjustable Range of Alarm Limits.....	60
9.5 Alarm Information and Prompt	60
Chapter 10 Other Functions	62
10.1 Nurse Call	62
10.2 Network.....	62
10.3 Central Monitoring System.....	62
Chapter 11 Accessories	63
Chapter 12 Warranty and Service.....	66
12.1 Warranty	66
12.2 Contact Information	66
Appendix A Specifications.....	67
A.1 Classification.....	67
A.2 Specifications	67
A.2.1 Size and Weight.....	67
A.2.2 Function Configuration	67
A.2.3 Environment.....	67
A.2.4 Display	68
A.2.5 Battery	68
A.2.6 Recorder	69
A.2.7 Review.....	69
A.2.8 SpO ₂	69
A.2.9 PR.....	70
A.2.10 CO ₂	70
Appendix B EMC Information-Guidance and Manufacture's Declaration.....	73
B.1 Electromagnetic Emissions	73
B.2 Electromagnetic Immunity	73
B.3 Electromagnetic Immunity	75
B.4 Recommended Separation Distances	78
Appendix C Abbreviation	79

Chapter 1 Intended Use and Safety Guidance

1.1 Intended Use/Indications for Use

The Vital Signs Monitor is indicated for use for non-invasive continuous monitoring of oxygen saturation of the blood (SpO₂) and CO₂.

The Vital Signs Monitor is intended to be used only under regular supervision of clinical personnel. It is adaptable to adult, pediatric, and neonatal usage in a hospital environment and intra-hospital moves.

The Vital Signs Monitor is equipped with alarms that indicate system faults (such as loose or defective electrodes), physiologic parameters that have exceeded the limits set by the operator, or both.

1.2 Safety Guidance

1.2.1 Environment

Follow the instructions below to ensure a completely safe electrical installation. The environment where the monitor will be used should be reasonably free from vibration, dust, corrosive or explosive gases, extremes of temperature, humidity, and so on. For a cabinet mounted installation, allow sufficient room at the front for operation and sufficient room at the rear for servicing with the cabinet access door open.

The monitor operates within specifications at ambient temperatures between 0 °C and 40 °C. Ambient temperatures that exceed these limits could affect the accuracy of the instrument and cause damage to the modules and circuits. Allow at least 2 inches (5cms) clearance around the instrument for proper air circulation.

1.2.2 Power Source Requirements

Refer to *Appendix A*.

1.2.3 Grounding the Monitor

To protect the patient and hospital personnel, the cabinet of the monitor must be grounded. Accordingly, the monitor is equipped with a detachable 3-wire cable which grounds the instrument to the power line ground (protective earth) when plugged into an appropriate 3-wire receptacle. If a 3-wire receptacle is not available, consult the hospital electrician.

Connect the grounding wire to the equipotential grounding terminal on the mains system. If it is not evident from the instrument specifications whether a particular instrument combination is hazardous or not, for example due to summation of leakage currents, the user should consult the manufacturers concerned or an expert in the field, to ensure that the necessary safety of all instruments concerned will not be impaired by the proposed combination.

1.2.4 Equipotential Grounding

Protection class 1 instruments are already included in the protective grounding (protective earth) system of the room by way of grounding contacts in the power plug. For internal examinations on the heart or the brain, the monitor must have a separate connection to the equipotential grounding system. One end of the equipotential grounding cable (potential equalization conductor) is connected to the equipotential grounding terminal on the instrument rear panel and the other end to one point of the equipotential grounding system. The equipotential grounding system assumes the safety function of the protective grounding conductor if ever there is a break in the protective grounding system. Examinations in or on the heart (or brain) should only be carried out in medically used rooms incorporating an equipotential grounding system. Check each time before use that the instrument is in perfect working order. The cable connecting the patient to the instrument must be free of electrolyte.

WARNING

If the protective grounding (protective earth) system is doubtful, the monitor must be supplied by internal power only.

1.2.5 Condensation

Make sure that during operation, the instrument is free of condensation. Condensation can form when equipment is moved from one building to another, thus being exposed to moisture and differences in temperature.

1.2.6 Safety Precautions

WARNING and **CAUTION** messages must be observed. To avoid the possibility of injury, observe the following precautions during the operation of the instrument.

WARNING

- 1 The monitor is intended to be used by qualified physicians or personnel professionally trained. And they should be familiar with the contents of this user manual before operation.
 - 2 Only qualified service engineers can install this equipment. And only service engineers authorized by EDAN can open the shell.
 - 3 **EXPLOSION HAZARD**-Do not use the device in a flammable atmosphere where concentrations of flammable anesthetics or other materials may occur.
 - 4 **SHOCK HAZARD**-To avoid the **RISK** of electric shock, this equipment must only be connected to a **SUPPLY MAINS** with protective earth.
 - 5 Do not attempt to connect or disconnect a power cord with wet hands. Make certain that your hands are clean and dry before touching a power cord.
 - 6 Do not service or maintain the monitor or any accessory which is in use with the patient.
 - 7 This monitor is not a device for treatment purposes.
-
-

WARNING

- 8 If liquid is inadvertently splashed on the equipment or its accessories, or it may enter the conduit or inside the monitor, contact local Customer Service Center.
 - 9 Accessory equipment connected to the analog and digital interfaces must be certified according to the respective IEC/EN standards (e.g. IEC/EN60950 for data processing equipment and IEC/EN60601-1 for medical equipment). Furthermore all configurations shall comply with the valid version of the system standard IEC/EN60601-1. Everybody who connects additional equipment to the signal input connector or signal output connector configures a medical system, and is therefore responsible that the system complies with the requirements of the valid version of the system standard IEC/EN 60601-1. If in doubt, consult our technical service department or your local distributor.
 - 10 Do not unplug the USB storage during storing data. If the damaged data caused by unplugging the USB storage during data storing cannot be deleted on the monitor, the user can delete it on the PC.
 - 11 Do not solder the leading wire and the battery terminal directly.
 - 12 Always keep the battery away from fire.
 - 13 If liquid leaking from the battery gets into your eyes, onto your skin or clothes, do not rub your eyes. Wash them well with clean water and go to see a doctor immediately.
 - 14 Stop using the battery if abnormal heat, odor, discoloration, deformation or abnormal condition is detected during use, charge, or storage. Keep it away from the monitor.
 - 15 Do not use a battery with serious scratch or deformation.
 - 16 Only patient cable and other accessories supplied by EDAN can be used. The performance and electric shock protection cannot be guaranteed, and the patient may be injured otherwise. Prior to use, check if the casing of a disposable or sterilized accessory is intact. Do not use it if its casing is damaged.
 - 17 Please set the alarm according to the individual status of patient to avoid delaying treatment. Ensure there will be alarm audio prompt when an alarm occurs.
 - 18 Devices connecting with monitor should be equipotential.
 - 19 When the monitor and electrosurgical device are used together, the user (physician or nurse) should guarantee the safety of patient.
 - 20 The monitor can provide protective means to prevent the patient from being burned when used with HF SURGICAL EQUIPMENT. Use only accessories approved by EDAN.
 - 21 The simultaneous use of cardiac pacemaker and other patient-connected equipment may cause safety hazard.
 - 22 Please disinfect timely to prevent cross infection between patients.
 - 23 The equipment can protect against the effects of the discharge of a defibrillator.
 - 24 During monitoring, if the power supply is off and there is no battery for standby, the monitor will be off. All last settings used will be recovered when the power is restored.
 - 25 The appliance coupler or mains plug is used as isolation means from supply mains. Position the monitor in a location where the operator can easily access the disconnection device.
-
-

WARNING

- 26 Do not touch the patient, bed or instrument during defibrillation.
 - 27 The monitor is equipped with a wireless AP/Wi-Fi via network interface to receive RF electromagnetic energy. Therefore, any other equipment complies with CISPR radiation requirements may also interfere with the wireless communication and make it interrupted.
 - 28 Wireless LAN equipment contains an intentional RF radiator that has the potential of interfering with other medical equipment, including patient implanted devices. Be sure to perform the electromagnetic compatibility test before installation and any time new medical equipment is added to the Wireless LAN coverage area.
 - 29 CO₂ module shall be avoided from crash and vibration.
 - 30 Without any external memory, all data measured (including trend data, review data, alarm events and so on) are cleared either when the monitor is turned off or when the monitor is powered down in the process of monitoring.
 - 31 Additional multiple socket-outlet or extension cord can't be connected to the system.
 - 32 Only items that have been specified as part of the system or specified as being compatible with the system can be connected to the system.
 - 33 SHOCK HAZARD - Don't connect electrical equipment, which has been supplied as a part of the system, directly to the wall outlet when the non-medical equipment is intended to be supplied by a multiple portable socket-outlet with an isolation transformer.
 - 34 SHOCK HAZARD - Don't connect electrical equipment, which has not been supplied as a part of the system, to the multiple portable socket-outlet supplying the system.
 - 35 Do not touch accessible parts of medical or non-medical electrical equipment in the patient environment and the patient simultaneously, such as USB connector, VGA connector or other signal input/output connectors.
 - 36 Using accessories other than those specified may result in increased electromagnetic emission or decreased electromagnetic immunity of the monitoring equipment.
 - 37 The monitor should not be used adjacent to or stacked with other equipment. If adjacent or stacked use is necessary, you must check that normal operation is possible in the necessary configuration before you start monitoring patients.
 - 38 The medical electrical equipment needs to be installed and put into service according to the EMC Information provided in this user manual.
 - 39 The monitors are intended for use by trained healthcare professionals in hospital environments.
 - 40 Operation of the equipment exceeding specified physiological signal or the operational specification may cause inaccurate results.
-
-

WARNING

- 41 Setting alarm limits to extreme values may cause the alarm system to become ineffective. It is recommended to use the default settings.
 - 42 Only recommended batteries can be used for the monitor.
 - 43 If several items of medical equipment are interconnected, pay attention to the sum of the leakage currents, otherwise it may cause shock hazard. Consult your service personnel.
 - 44 Connecting any accessory (such as external printer) or other device (such as the computer) to this monitor makes a medical system. In that case, additional safety measures should be taken during installation of the system, and the system shall provide:
 - a) Within the patient environment, a level of safety comparable to that provided by medical electrical equipment complying with IEC/EN 60601-1, and
 - b) Outside the patient environment, the level of safety appropriate for non-medical electrical equipment complying with other IEC or ISO safety standards.
 - 45 All the accessories connected to system must be installed outside the patient vicinity, if they do not meet the requirement of IEC/EN 60601-1.
 - 46 Portable and mobile radio frequency (RF) communications equipment can affect medical electrical equipment, please refer to the recommended separation distances provided in Appendix A2 EMC Information.
 - 47 If leakage or foul odor is detected, ensure that there's no fire around.
 - 48 When the monitor is used with HF surgical equipment, the transducer and the cables must be avoided from conductive connection to the HF equipment. This is to protect against burns to the patient.
 - 49 To protect the monitor from damage during defibrillation, for accurate measurement information and to protect against noise and other interference, use only accessories specified by EDAN.
 - 50 No modification of this equipment is allowed without authorization of the manufacturer. If this equipment is modified, appropriate inspection and testing must be conducted to ensure continued safe operation.
 - 51 Clinical decision making based on the output of the device is left to the discretion of the provider.
 - 52 The device must be connected to the ground to avoid signal interference.
 - 53 Portable RF communications equipment (including peripherals such as antenna cables and external antennas) should be used no closer than 30 cm (12 inches) to any part of the monitor, including cables specified by the manufacturer. Otherwise, degradation of the performance of this equipment could result.
 - 54 Make sure networking function is used in a secure network environment.
-
-

WARNING

- 55 Route all cables carefully to avoid possible entanglement, apnea, or electrical interference. For the device mounted over the patient, sufficient precautionary measures should be taken to prevent it from falling on the patient.
 - 56 The monitor is suitable for use in the presence of electrosurgery. When the monitor is used with HF surgical equipment, user (doctor or nurse) should be cautious about patient safety.
-
-

CAUTION

- 1 Federal law restricts this device to sale by or on the order of a physician.
 - 2 Electromagnetic Interference- Ensure that the environment in which the monitor is installed is not subject to any sources of strong electromagnetic interference, such as radio transmitters, mobile telephones, microwaves, etc.
 - 3 The monitor is designed for continuous operation and is “ordinary” (i.e. not drip or splash-proof).
 - 4 Keep the environment clean. Avoid vibration. Keep it far from corrosive medicine, dust area, high-temperature and humid environment.
 - 5 Do not immerse transducers in liquid. When using solutions, use sterile wipes to avoid pouring fluids directly on the transducer.
 - 6 Disposable devices are intended for single use only. They should not be reused as performance could degrade or contamination could occur.
 - 7 Assembly of the monitor and modifications during actual service life shall be evaluated based on the requirements of IEC60601-1.
 - 8 Avoid liquid splash and excessive temperature. The temperature must be kept between 0 °C and 40 °C while working. And it should be kept between -20 °C and 55 °C during transportation and storage.
 - 9 If the monitor gets damp, put it in dry circumstance to dry it until it can work normally. If liquid pours on the monitor, please contact the service personnel authorized by EDAN.
 - 10 A potential hazard can exist if different alarm presets are used for the same or similar equipment in any single area.
 - 11 Remove a battery whose life cycle has expired from the monitor immediately.
 - 12 The device and reusable accessories may be sent back to the manufacturer for recycling or proper disposal after their useful lives. Alternatively, they can be returned to the dealer or the manufacturer for recycling or proper disposal. Batteries are hazardous waste. Do not dispose them together with house-hold garbage. At the end of their life hand the batteries over to the applicable collection points for the recycling of waste batteries. For more detailed information about recycling of this product or battery, please contact your local Civic Office, or the shop where you purchased the product.
 - 13 Poor connection might be caused by frequently plugging and unplugging the power cord. Check the power cord regularly and replace it in time.
-
-

CAUTION

- 14 Before using the device, the equipment, patient cable and electrodes etc. should be checked. Replacement shall be taken if there is any evident defect or signs of aging which may impair the safety or performance.
-
-

NOTE:

- 1 Position the device in a location where the operator can easily see the screen and access the operating controls.
- 2 The monitor can only be used on one patient at a time.
- 3 This equipment is not intended for home use.
- 4 If the device is discolored or damaged, then discontinue the use of the device.
- 5 The pictures and interfaces in this manual are for reference only.
- 6 Regular preventive maintenance should be carried out every two years. You are responsible for any requirements specific to your country.
- 7 The materials with which the patient or any other person can come into contact conform to the standard of EN ISO 10993-1: 2013.
- 8 It is recommended to format the USB flash drive to the FAT file type via PC prior to use.
- 9 To protect eyes from damage, don't look directly at supplementary light for long time.
- 10 When there's measurement beyond range, invalid measurement or no measurement value, it will display ---.
- 11 In normal use, the operator shall stand in front of the monitor.

1.2.7 Protecting Personal Information

Protecting personal health information is a major component of security strategy. To protect the personal information and ensure the proper device performance, the user should take necessary precautions in accordance with local laws and regulations and institution's policies. EDAN recommends health care organizations or medical institutions to implement a comprehensive and multifaceted strategy to protect the information and systems from internal and external security threats.

To ensure the patients' safety and protect their personal health information, the user should implement security practices or measures that include:

1. Physical safeguards - physical safety measures to ensure that unauthorized personnel do not have access to the monitor.
2. Operational safeguards - safety measures during operation.
3. Administrative safeguards - safety measures in management.
4. Technical safeguards - safety measures in technical field.

CAUTION

















- 1 The access/operation of the monitor is restricted to authorized personnel only. Assign only staff with a specific role the right to use the monitor.
 - 2 Ensure that all device components maintaining personal information (other than removable media) are physically secure.
 - 3 Ensure that the data are deleted after the patient is discharged. (Refer to Section 4.11 *Data Store*).
 - 4 Ensure that the monitor is connected only to the device authorized/approved by EDAN. Users should operate all EDAN deployed and supported monitors within EDAN authorized specifications, including EDAN approved software, software configuration, security configuration, etc.
 - 5 Protect all the passwords to prevent unauthorized changes.
 - 6 Anti-virus measures such as USB device virus scanning should be carried out prior to using USB flash drive.
 - 7 Firewalls and/or other security devices should be in place between the medical system and any externally accessible systems. It's recommended to use Windows defender firewall or any other firewall that can defend against Dos and DDos attacks, and keep it up to date.
 - 8 When the monitor is returned for maintenance, disposed of, or removed from the medical institution for other reasons, it is necessary to ensure that all patient data are removed from the monitor. (Refer to Section 4.11 *Data Store*).
 - 9 Please protect the privacy for the information and the data displayed on the screen, and for the information and the data stored in the monitor.
 - 10 When building the networking environment: 1) If a wireless router is used, please turn on the MAC address filtering function of the wireless router and add the MAC address of the monitor to the rule list. The wireless router only allows devices in the rule list to access the wireless network. 2) It is suggested to build a VLAN, assign the LAN ports where the approved switch port, monitor and MFM-CMS are into the same VLAN, and isolate it from other VLANs.
-
-







NOTE:

Log files generated by the monitor are used for system troubleshooting and do not contain protected medical data.

1.2.8 Explanation of Symbols on the Monitor

1		DEFIBRILLATION-PROOF TYPE BF APPLIED PART
---	-------------------------------------------------------------------------------------	-------------------------------------------

2		Caution
3		Operating instructions
4		Equipotential grounding
5		Power Supply switch
6		SERIAL NUMBER
7		CE marking
8		AUTHORISED REPRESENTATIVE IN THE EUROPEAN COMMUNITY
9		Date of manufacture
10		MANUFACTURER
11		Part Number
12		General symbol for recovery/recyclable
13		Disposal method
14		Caution: Federal (US) law restricts this device to sale by or on the order of a physician.
15		Ingress Protection IPX1 (Protected against vertically falling water drops)
16		Warning (Background: yellow; Symbol and outline: black)
17		Refer to User Manual (Background: blue; Symbol: white)

18		This Way Up
19		Fragile
20		Keep Away From Rain
21		Stacking Limit By Number
22		Handle with care
23		Do not step on
24	<p>ETL CLASSIFIED</p>  <p>Intertek 4005997</p>	<p>Conforms to UL Std. 60601-1, IEC Std. 60601-2-49 Certified to CSA Std. C22.2 No 601.1, CSA Std. C22.2 No 60601-2-49</p>

NOTE:

The user manual is printed in black and white.

Chapter 2 Installation of Monitor

NOTE:

To ensure that the monitor works properly, please read *Chapter 1 Intended Use and Safety Guidance*, and follow the steps before using the monitor.

2.1 Opening the Package and Checking

Open the package and take out the monitor and accessories carefully. Keep the package for possible future transportation or storage. Check the components according to the packing list.

- Check for any mechanical damage.
- Check all the cables, modules and accessories.

If there is any problem, contact the manufacturer or local representative immediately.

2.2 Connecting the Power Cable

Connection procedure of the AC power line:

- Make sure the AC power supply complies with following specification: 100 V-240 V~, 50 Hz/60 Hz.
- Connect the power cord provided with the monitor. Connect the power cord to connector of the monitor. Connect the other end of the power cord to a grounded power outlet.

NOTE:

Connect the power line to the jack special for hospital usage.

- Connect to the ground line if necessary. Refer to Chapter 1.2 *Safety Guidance* for details.

NOTE:

When the battery configuration is provided, after the device is transported or stored, the battery must be charged. Switch on AC power supply can charge the battery no matter if the monitor is powered on.

2.3 Powering on the Monitor

Power on, LOGO information will be displayed on the screen.

WARNING

Do not use it on any patient if any sign of damage is detected, or the monitor displays some error messages. Contact biomedical engineer in the hospital or Customer Service Center immediately.

NOTE:

- 1 Check all the functions of the monitor and make sure that the monitor is in good status.
- 2 If rechargeable batteries are provided, charge them after using the monitor every time to ensure the electric power is enough.

- 3 After long-time continuous running, please restart the monitor to ensure the monitor's steady performance and long lifespan.
- 4 If the system is not used for a longer period of time, its system time may be inaccurate. In this case, reset the system time after powering on.
- 5 If the system time cannot be saved and resumes the default value after restart, contact the service department of EDAN to replace the button cell in main board.

2.4 Connecting Sensor to Patient

Connect all the necessary patient sensors between the monitor and the patient.

NOTE:

For information on correct connection, refer to related chapters.

2.5 Checking the Recorder

If your monitor is equipped with a recorder, open the recorder door to check if paper is properly installed in the slot. If no paper present, refer to *Chapter 6 Trend and Recording* for details.

Chapter 3 Introduction

3.1 General Information

The monitor integrates the function of parameter measurement modules, display, recording and output to compose a compact, portable device. Its built-in replaceable battery provides convenience for patient movement. On the LCD display screen, SpO₂ waveform, CO₂ waveform and all the monitoring parameters can be displayed clearly.

You may frequently use the following functions:

- SpO₂ monitoring (Refer to Chapter *Monitoring SpO₂* for details)
- CO₂ monitoring (Refer to Chapter *Monitoring CO₂* for details)
- Alarm (Refer to Chapter *Alarms* for details)

The monitor is a user-friendly device with operations conducted by a few buttons on the front panel. Refer to *3.3 Button Functions* for details.



Figure 3-1 M3B Vital Signs Monitor

The monitor can monitor:

- SpO₂: Arterial oxygen saturation (SpO₂);
- Pulse Rate (PR);

- SpO₂ PLETH (Plethysmogram);
- CO₂: End Tidal CO₂ (EtCO₂);
- Fraction of inspired CO₂ (FiCO₂);
- Air Way Respiration Rate (AwRR).

The monitor provides extensive functions as visual and audible alarm, net connection, nurse call, recording and storage for trend data, SpO₂/CO₂ measurements review, net connection, nurse call, alarm events and so on. Recording and mobile storage are optional functions for monitor.

3.2 Screen Display

The monitor is equipped with LCD. The patient parameters, waveforms, alarm messages, bed number, time, monitor status and other data can be reflected from the screen.

The screen is divided into three areas:

- 1 Information area ① ④
- 2 Parameter area ②
- 3 Waveform/Trend table/Alarm list area ③

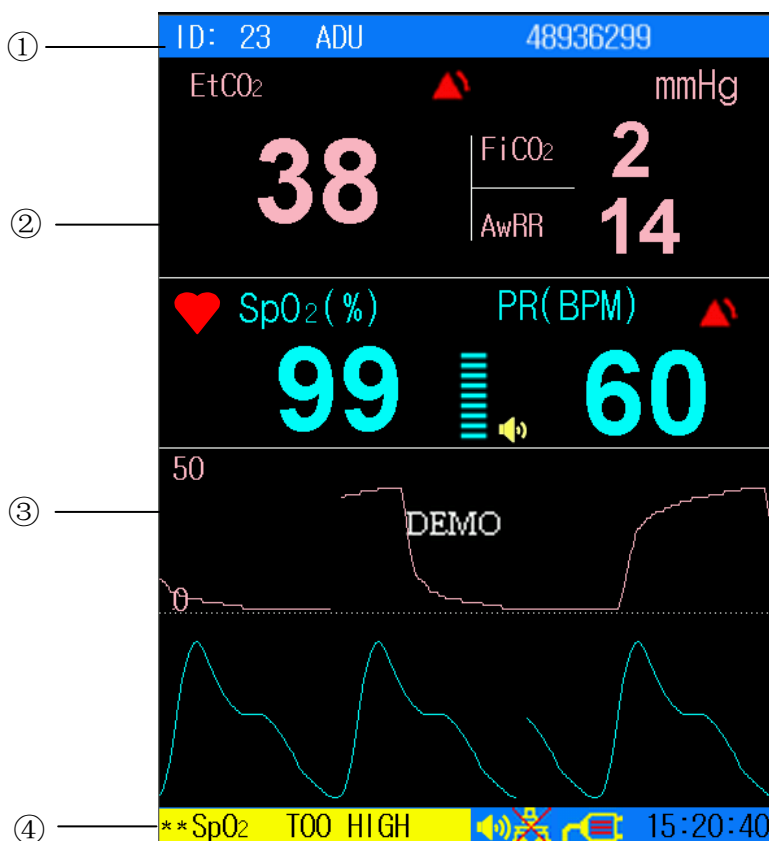

Figure 3-2 Main Display with Waveform

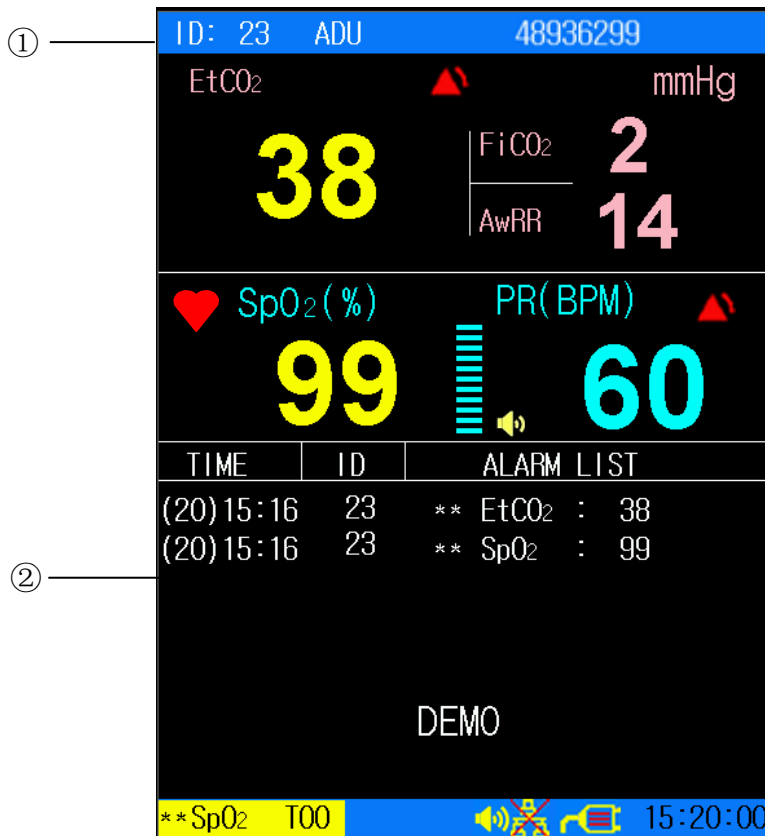

Figure 3-3 Main Display with List

The display on the screen can be changed to a trend graph as follows:

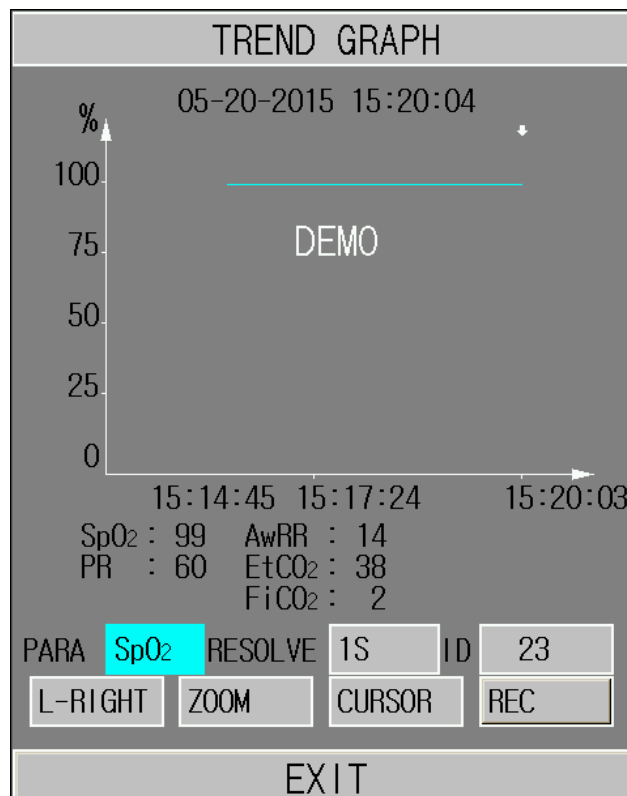













Figure 3-4 Display Trend Graph

The icons on the interface and their meanings are as follows:

	Battery status indicator
	Barcode
	Connected to mains power supply
	Volume indicator
	Network connection
	Network connection off
	Medium/Low alarm icon
	High alarm
	Audio alarm off
	Audio alarm paused
	Parameter alarm off
ADU	Patient type: ADU
PED	Patient type: PED
NEO	Patient type: NEO
	Heart beat
ID	Current patient ID
15:20:00	Current time

Information Area (① ④)

The Information areas are to display operating status of the monitor and condition of the patient, including the following data:

- Patient ID;
- Signs indicating the net connection status;
- Signs indicating the battery or mains power supply status;

- Current time;
- Signs indicating the volume status;
- Signs indicating the sensor off or alarm off.

Parameter Area (②)

Parameter area is on the right of Waveform area, and parameters are displayed:

SpO₂:

- SpO₂ (Unit: %)
- PR (Pulse Rate, unit: BPM)
- SpO₂ alarm limit

CO₂:

- EtCO₂ (unit: mmHg, kPa or %)
- FiCO₂ (unit: mmHg, kPa or %)
- AwRR (Unit: times/minute)

Waveform Area/Trend Table/Alarm List (③)

It can display SpO₂ and CO₂ waveform, Trend graph, Trend tab or Alarm list. You can select it in **SELECTION** of **SYSTEM MENU**.

Alarm Indicator and Alarm Status

Under normal status, the alarm indicator does not light.

When an alarm is generated, the alarm indicator lights or flashes. The color of light represents the alarm level. Refer to *Chapter 5 Alarm* for details.

Refer to the relevant content of parameters for alarm information and prompt.

Charge Indicator and Charge Status

To indicate the status of charging: when the battery is being charged, the light turns to yellow; after the charge is finished, the light will be off.

3.3 Button Functions

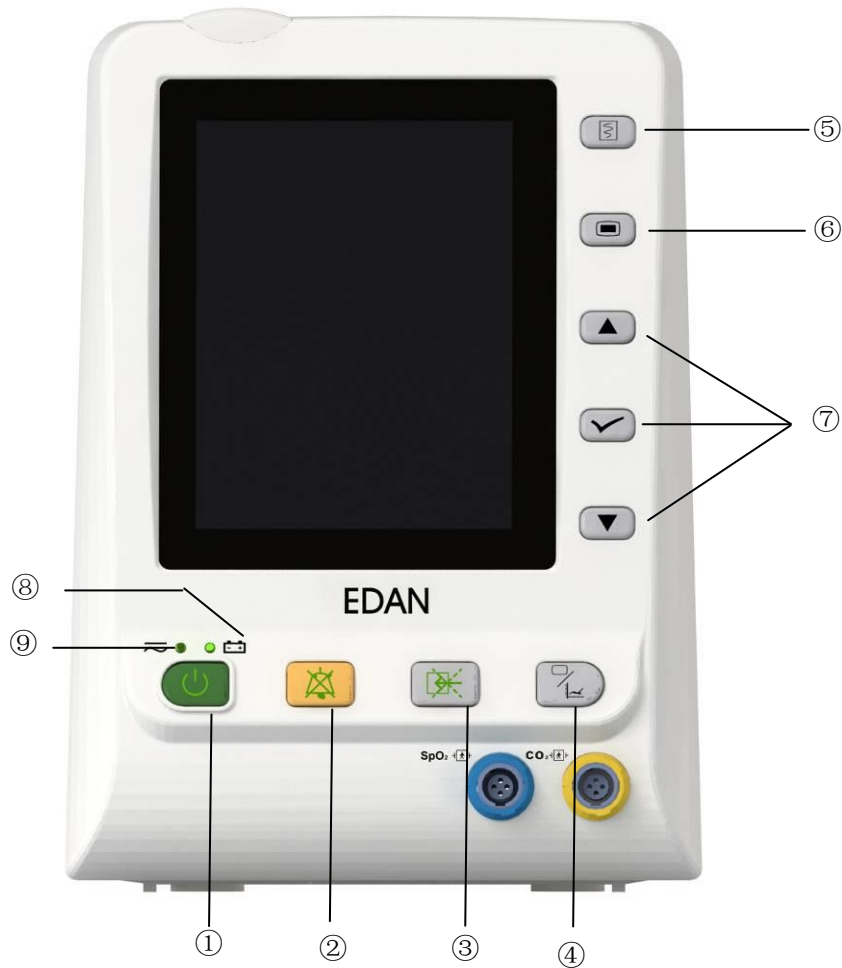













Figure 3-5 Buttons

All the operations to the monitor can be finished by several buttons. They are:

①	ON/OFF 	When the monitor is off, press this button to switch on the monitor. When the monitor is on, press this button and hold for 2s to switch off the monitor; press this button for less than 1s, the monitor will enter the sleep mode.
②	AUDIO ALARM PAUSED/OFF 	Press this button to pause or turn off the auditory alarm as needed.
③	CO₂ START/STOP 	Press to start the CO ₂ measuring. During the measuring process, press the button to stop measuring.

④	TREND/WAVEFORM 	Press this button to switch between waveform, trend table and trend graph display.
⑤	RECORD 	Press to print out the currently displayed trend graph, trend table or alarm list.
⑥	MENU 	Press to call up the SYSTEM MENU . Refer to Chapter SYSTEM MENU for details.
⑦	UP  OK  DOWN 	Use the UP/DOWN button to select items in menu, and decrease or increase the items. Confirm the selection by OK button.

The icons on the front panel:

⑧	CHARGE Indicator 	The LED besides this icon indicates the charging status. When the battery is being recharged, the LED is bright.
⑨	POWER Indicator 	The LED besides this icon indicates the power status. When the monitor connects to the mains power supply, the LED is bright.

3.4 Interfaces

For the convenience of operator, interfaces of different function are in different sites of the monitor. There is a USB port on rear panel for Data storing function.

Left side of the monitor

At the left side of the monitor there is the recorder's paper inlet cover (①).



Figure 3-6 Front Panel and Left Panel

Sensor port on the front panel

Connectors for cables and sensors are as shown in Figure 3-6.

1. SpO₂ sensor connector ②
2. CO₂ sensor connector ③

WARNING

Only connect the device to EDAN supplied or recommended accessories.

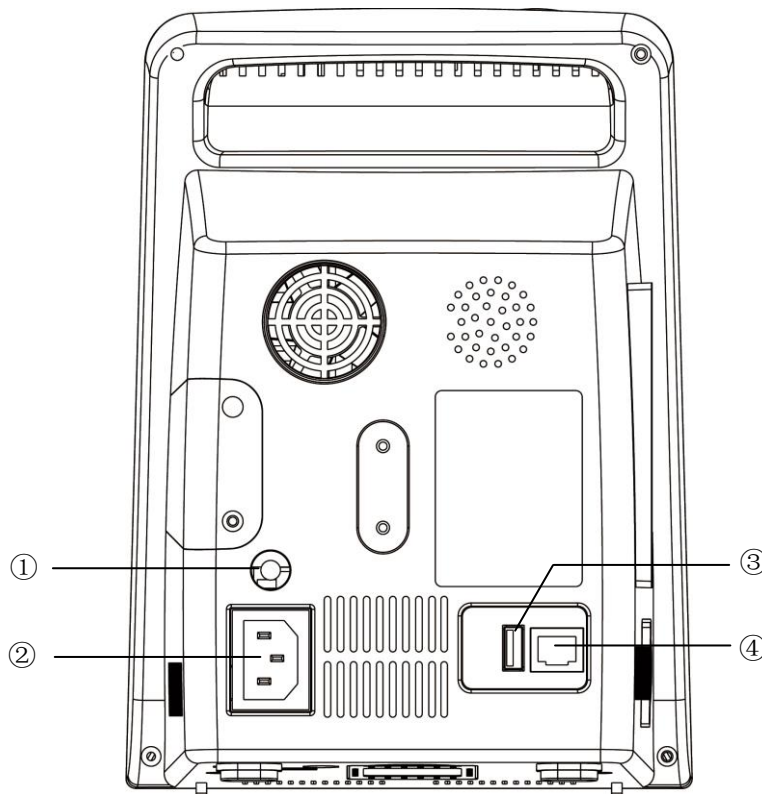

Figure 3-7 Rear Panel of M3B

Sockets on the rear panel are shown in Figure 3-7,

- ① Equipotential grounding terminal for connection with the hospital's grounding system.
- ② Power supply socket: 100 V-240 V~, 50 Hz/60 Hz.
- ③ USB connecting port for USB storage.
- ④ Network Interface: Standard RJ45 Socket, for connecting to MFM-CMS of EDAN.

Bottom panel

There are battery compartment and fuse box at the bottom panel.

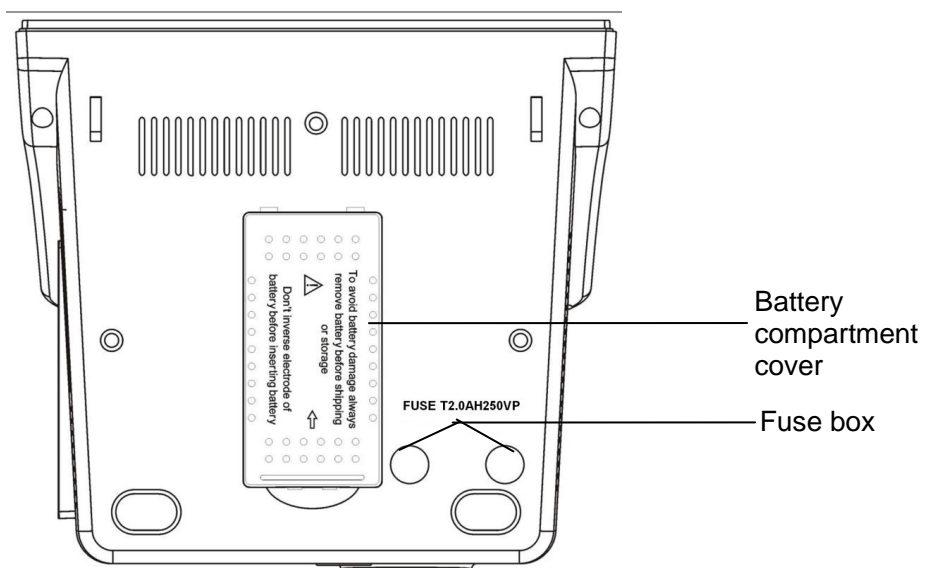







Figure 3-8 Bottom Panel

3.5 Built-in Rechargeable Battery





The monitor is equipped with a built-in rechargeable battery. When switching on AC power supply, the battery will be recharged automatically until full electric energy. There is a sign  or  in the lower right corner of screen.

- When the monitor is working with AC mains power, and it has no battery or the battery has full electric energy, it displays ;
- When the monitor is working with AC mains power, and the battery is being recharged, this icon flashes ;
- When the monitor is working with battery, it displays .

If the monitor is off, you can see charging status from the charger indicator. Battery status light is yellow when charging, off when full.

The battery is 90% to 100% charged after 300min of charging.

Battery status symbols show the status of battery and the battery power remaining;

-  Remaining battery power: 100%.
-  Remaining battery power: 75%
-  Remaining battery power: 50%
-  Remaining battery power: 25%
-  Batteries are almost depleted and need to recharge immediately.

Replace Battery

During monitoring state or communication state, when the electric energy of battery is low, the icon for indicating battery state will display and flash.

When the lifespan of battery is over, or foul odor and leakage has been detected, please contact the manufacturer or local distributor for replacement of battery.

WARNING

- 1 Do not take off the battery when monitoring. The unexpected power supply off cannot impact on the normal monitor working, if it has battery for standby.
- 2 Stop using the battery if abnormal heat, odor, discoloration, deformation or abnormal condition is detected during use, recharge, or storage. Keep it away from the monitor.
- 3 Make sure the monitor is used in the appointed range of voltage so that the effect of power supply cannot be noticed.
- 4 Before using the rechargeable lithium-ion battery (hereinafter called battery), be sure to read the user manual and safety precautions thoroughly.
- 5 Do not place battery in the monitor with the (+) and (-) in the wrong way around.
- 6 Do not connect the positive (+) and negative (-) terminals with metal objects, and do not put the battery together with metal objects, which can result in short circuits.

WARNING

- 7 Do not heat or throw battery into fire.
 - 8 Do not use, leave battery close to fire or other places where temperature may be above 60 °C. Do not immerse, throw, and wet battery in water/seawater.
 - 9 Do not destroy the battery; do not pierce battery with a sharp object such as a needle; do not hit with a hammer, step on or throw to cause strong shock; do not disassemble or modify the battery.
 - 10 Take out the battery before cleaning or storing the monitor for more than 1 month.
 - 11 The recommended battery can only be used for this monitor.
 - 12 The service life of the battery depends on the service frequency and time. The service life of the battery is about three years if the battery is well maintained and stored. The service life of the battery may shorten if it is used inappropriately. If the battery life is exhausted and not replaced in time, it may cause damage or heat to the device.
-
-

Battery Alarm Information

Technical Alarm:

Message	Cause	Alarm Level	What to do
Battery Low	Battery Low	High	Change the battery or charge the battery.

Chapter 4 System Menu

The monitor features in flexible configurations. You can configure various aspects of the monitor, including the parameters to be monitored, audio signal volume, and output content.

Press the **MENU** button on the front panel to call up **SYSTEM MENU**. You can perform the operations in this menu.

4.1 Patient Setup

Pick **PATIENT SETUP** in **SYSTEM MENU** to open the menu.

You can set the following patient information:

- **PAT ID**: Patient ID, 1-1000;
- **PAT TYPE**: Patient type; **ADU**, **PED**, or **NEO**.
- **BARCODE**: Display the patient barcode, maximum 20 bits.

Press the **UP/DOWN** button to select the items; then press the **OK** button to confirm.

Pick **EXIT** to return to the previous menu.

4.2 Default Setup

NOTE:

Select any item in this submenu to cancel the current setup and use the selected default setup.

- **FAC DEF CONFIG**: factory default configuration.
- **USER DEF CONFIG**: user-defined default configuration. The one labeled with ■ is current configuration.
- **CONFIRM**: Confirm your choice, exit this submenu, and return to the previous menu.

4.3 System Setup

- **ALARM VOL**: Set alarm volume for high, medium or low level, **HIGH**, **MED** or **LOW** are selectable.
- **STANDBY**: Set it to **ON** or **OFF** to turn on or off the Sleep Mode (Refer to 4.12 for details).
- **KEY VOL**: Set key volume to **HIGH**, **MED**, **LOW** or **OFF**.
- **BRIGHTNESS**: Set screen brightness to **HIGH**, **MED** or **LOW**.
- **SPHY VOL**: Set sphygmoc volume to **HIGH**, **MED**, **LOW** or **OFF**.
- **WAVE FORM**: Set displayed waveforms to **UNFILLED** or **FILLED**.
- **RECORDER SPEED**: Set recorder speed to **12.5 mm/s** or **25 mm/s**.
- **EXIT**: Select it to return to the previous menu.

4.4 Selection

Select **SELECTION** in **SYSTEM MENU** to access the following submenu, in which six selections are available: **CO₂ TREND TAB**, **SpO₂ TREND TAB**, **ALARM LIST**, **ALL PARAMETERS**, **TREND TABLE** and **TREND GRAPH**. Only one item can be selected to display information in the interface.

- **CO₂ TREND TAB**: to display CO₂ trend table:
- **SpO₂ TREND TAB**: to display SpO₂ trend table;
- **ALL PARAMETERS**: to display parameters trend list of SpO₂ and CO₂ in this area;
- **ALARM LIST**: to display alarm trend list.
- **TREND GRAPH**: select this item to display the trend graph.
- **TREND TABLE**: select this item to display the trend table.

Press **TREND/WAVEFORM** to change the trend list or trend graph to waveform display.

4.5 Deleting Data

If you press the button  when a trend list or an alarm list is displayed onscreen, the menu will pop up:

DELETE ID: Entirely delete the trend and alarm data of the current monitored patient.

DELETE ALL DATA: Entirely delete the trend and alarm data of all the monitored patients.

Select **YES** to make the operation effective; select **NO** to cancel the operation.

4.6 Version

Select **VERSION** in **SYSTEM MENU** to see the version of the monitor or the module details.

4.7 Time Setup

Select **TIME SETUP** in **SYSTEM MENU** to access the submenu of **TIME SETUP** as shown. System time is in format of **Y-M-D**, **M-D-Y**, and **D-M-Y**. Users can set the year, month, day, hour, minute and second. Pick the item you want to modify and confirm it using **OK**. Select **EXIT** item to save the setup and return to the previous menu. If you want to exit the menu without saving it, press the **MENU** button on front panel.

4.8 CO₂ Setup

Select **CO₂ SETUP** in **SYSTEM MENU** to open the menu:

- **WAVE SCALE**: Adjust full scale size of CO₂ waveform display area with **LOW** or **HIGH** selectable. The default value is **LOW**.
- **BARO PRESS**: Set the barometric pressure value.
- **O₂ COMPENS**: Adjust the O₂ compensating concentration as per the selection of the user.

- **ANE AGENT:** Adjust the anesthetic compensating concentration as per the selection of the user.
- **BALAN GAS:** Balance the gas compensating operations.
- **APNEA ALM:** After selecting the alarm time for **APNEA** alarm (having 7 levels, which are **10 S, 15 S, 20 S, 25 S, 30 S, 35 S** and **40 S**), the **CO₂ APNEA** information will appear on the screen after the corresponding selected time. The alarm level is **HIGH**.
- **ZERO CAL:** Perform CO₂ model zero calibration.

WARNING

Connect the CO₂ module to the monitor, press the **CO₂ START/STOP** button, and then select the **ZERO CAL** in menu to start the zero calibration.

See the function details of the items in *Chapter 9 CO₂ Measuring*.

4.8 Alarm Setup

Please refer to *5.1.3 Alarm Setup*.

4.9 Maintain

Select **SYSTEM MENU > MAINTAIN** to open **ENTER MAINTAIN PASSWORD**, in which you can enter password and then customize maintenance settings. Factory maintenance function is only available for the service engineers of EDAN or representative authorized by EDAN.

User Maintain

Input the password **9 9 8 1** in the **USER KEY** box and press **OK** button, the **USER MAINTAIN** menu will pop up, in which you can set the following items.

BED No.: set the bedside number to a value between 1 and 64.

LANGUAGE: set the displayed language.

NOTE:

Users should restart the monitor after changing the language.

NURSE CALL: turn on or off the nurse call. When the parameter alarm condition is active, the monitor gives 3s nurse call alarm prompt; if the audio alarm or the audio system is off, the monitor can also give the nurse call alarm in abnormal condition.

Normally open relay contacts between pin7 and pin8 of RJ45 connector. Contacts closed when any alarm is audible.

SERVER IP: The default server IP is 202.114.4.119, it can be changed by the user according to the IP of PC installed with MFM-CMS of EDAN.

SERVER PORT: set server port.

PRES UNIT: Set the pressure unit to **mmHg, kPa** or **%**.

COLOR SELECT: set the displaying color of waveforms:

OTHER SETUP

● SpO₂ SETUP

Access **SpO₂ SETUP** and you can see the menu.

◆ SpO₂ ALARM LEV

You can configure the alarm level for **SpO₂ SENSOR OFF** to **HIGH** or **LOW**.

◆ SENSITIVITY

The SpO₂ reading is the average of data collected within a specific time. You can set **Sensitivity** to **HIGH, MED** or **LOW** via the menu. The higher the sensitivity is, the quicker the monitor responds to the changes in the patient's oxygen saturation level. Contrarily, the lower the sensitivity is, the slower the monitor responds to the changes in the patient's oxygen saturation level, but the measurement accuracy will be improved. When a critical patient is monitored, selecting high sensitivity will help to understand the patient's state.

◆ PI

PI is a numeric value indicating perfusion level. It reflects the perfusion level at the monitoring site. You can set it **ON** or **OFF**.

● ALARM SETUP

◆ AUDIO ALARM PAUSED

To activate the Audio Alarm Paused function, please set **AUDIO ALARM PAUSED** to **60 S**,

120 S or **180 S**, and then press the button  on the front panel to pause audio alarm. The information area displays the remaining pause time in seconds with a yellow background. Key sounds and beat sounds keep their previous status. Auditory alarm will resume when you

press the button  again or the pause time terminates.

◆ AUDIO ALARM OFF

To activate the Audio Alarm Off function, please set **AUDIO ALARM OFF** to **ON**, then

press the button  on the front panel and hold it for more than three seconds to turn off auditory alarm. Key sounds and beat sounds keep their previous status. Press the button

 again to resume auditory alarm. If you set **AUDIO ALARM OFF** to **OFF**, the function is inactivated.

● BARCODE SETUP

◆ ID:

Patient ID can maximally be a three-digit number. On this precondition, you can determine which digit in the barcode is the starting/ending digit for the patient ID via configuration of **START** and **END**. Take the following barcode for example. If you set **START** to **2** and **END** to **4**, the updated patient ID will begin with the second digit and end with the fourth

digit in the barcode, namely 787.

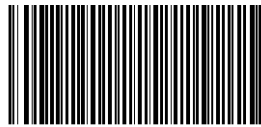

9787121113260

◆ **PAT TYPE:**

You can determine which digit in the barcode indicates the patient type. For example, if you set **PAT TYPE** to **1**, the first digit in the barcode will be identified as an indication of patient type.

◆ **ON/OFF:**

If it is set to **ON**, the patient information is updated automatically by using a barcode scanner. If it is set to **OFF**, a message box indicating “**Confirm to update patient, yes?**” will pop up when scanning a barcode. Click on **YES** to automatically update patient information; click on **NO** to quit automatically update.

◆ **ADU, PED, NEO:**

Select a digit from 0~9 to indicate the patient type. For example, if **ADU** is set to **9**, **PAT TYPE** is set to **1**, and the first digit in the barcode is 9, the patient type could be updated to ADU.

NOTE:

- 1 The set value of **START/END** in **ID** as well as the set value of **PAT TYPE** must not exceed the length of the barcode.
- 2 If **START/END** is set to **0**, the patient ID will not be updated by using barcode scanner.
- 3 If **PAT TYPE** is set to **0**, the patient type will not be updated by using barcode scanner.
- 4 Barcodes containing characters other than digits or containing space will be considered invalid and cannot be identified. If any invalid character is detected, a message box indicating “**Special signs are in code bar!**” will pop up.
- 5 Connect the barcode scanner to the monitor and wait 10 seconds before starting the scanner.
- 6 Refer to the accompanying operator’s manual of the scanner for more information about its usage.

EXIT: exit the menu.

- **SAVE CURRENT AS USER CONFIG:** Save the current setup as user default configuration.

Factory Maintain

Factory maintenance function is only available for the service engineers of EDAN or representative authorized by EDAN.

4.10 Data Store

The monitor can support the USB storage for the Data Store function. Enter the menu by **SYSTEM MENU > DATA STORE** to set the data storing function. You can set the storing interval, browse data, search data, and delete all the data or single item data.

- **ON/OFF**: set the Data Store function to **ON** or **OFF**.

Data stored in U disk consists of several folders, when the capacity of each ID folder exceeds 512 KB, it will create a new folder and continue to store data. Data quantity depends on the capacity of U disk. When U disk is full, the monitor will prompt an alarm “Disk is not enough.” U disk cannot store waves.

WARNING

- 1 If you want to stop the data storing function, you should set this item to **OFF** before unplugging the USB disk.
- 2 Do not unplug the USB storage when storing data. If the damaged data caused by unplugging the USB storage during data storing cannot be deleted on the monitor, the user can delete them on the PC.

NOTE:

1. If you set the item to **ON**, after restarting the monitor, this item will store data automatically, otherwise you will have to manually store data.
2. If formatting is failed, try again. Restart the monitor and retry the formatting, or contact the service personnel of the manufacturer if formatting is failed repeatedly.

- **INTERVAL**: set the storing interval by this item, it can be set to **1 S, 5 S, 10 S, 30 S, 1 MIN** or **5 MIN**.

- **MANAGEMENT**: select **BROWSE** to browse data stored before.

- **DELETE ALL**: Select this item to delete all the data stored before. The dialog box displays:
All records will be deleted, OK?

Select **YES** to delete all the data.

- **UP-DOWN**: Select this item, and then turn the page by pressing the **UP** or **DOWN** to browse data.

- **SEARCH**: Search data by **PATIENT ID, DATE** and **TIME**, then **CONFIRM** it.

- **RETURN**: Select this item to return to the previous menu.

Select the single item data in **DATA BROWSER** menu, press **OK** button to display the **DATA BROWSER** menu:

The user can select to browse **TREND TABLE, TREND GRAPH** or **ALARM LIST** of SpO₂ or CO₂. For example, select **TREND TABLE** to display.

User can select **DELETE** to delete the single item data; or select the **RETURN** to return to the previous menu.

NOTE:

The data which is being stored cannot be browsed in real time. Before searching data, you should turn off the **Data Store** function at first.

4.11 Sleep Mode

Entering Sleep Mode

Select **SYSTEM MENU > SYSTEM SETUP > STANDBY** and configure the item to **ON**. Then you will see the dialog after pressing the switch for less than 1s: **Enter sleep mode, yes?**

Select **YES** to enter the Sleep mode.

NOTE:

When the **SYSTEM SETUP > STANDBY** is **OFF**, or the monitor is in **DEMO** mode, or there is any inputting signal, pressing the **ON/OFF** button cannot make the monitor enter the sleep mode.

Quitting Sleep Mode

In the sleep mode, if a new signal occurs or you press any button on the front panel, the monitor will enter the working mode.

NOTE:

- 1 If the following situation occurs, monitor will return to normal monitoring mode automatically: the monitor receives physiological signal of SpO₂, and lasts for 5s; if the monitor is powered by battery, when the battery electric energy is low, it will enter normal monitoring mode, and indicates low battery alarm.
- 2 In DEMO mode, the monitor cannot enter Sleep mode.

Chapter 5 Alarm

This chapter gives general information about the alarm and measures to be taken accordingly. Alarm setup is provided in respective parameter setup sections.

WARNING

A potential hazard can exist if different alarm presets are used for the same or similar equipment in any single area, e.g. an intensive care unit or cardiac operating room.

5.1 Alarm Modes

5.1.1 Alarm Level

Each alarm, either technical or physiological, has its own level. For alarm of higher level, when the alarm condition is active, the system will give prompt in various ways. Alarms in the monitor are divided into three levels: High, Medium and Low.

High-level alarm indicates the patient's life is in danger or the monitor has serious problem in technical respect. It is the most serious alarm.

Medium-level alarm means serious warning.

Low-level alarm is a general warning.

Alarms are classified into physiological alarm and technical alarm. Physiological alarms refer to those alarms triggered by patient's physiological situation which could be considered dangerous to his or her life. Technical alarm refer to system failure which can make certain monitoring process technically impossible or make monitoring result unbelievable. Technical alarm is also called System Error Message.

The monitor has pre-set the alarm levels for the parameters.

Alarm level of the System Error Message (technical alarm) is pre-set in the system.

The alarm levels for technical alarms, general alarms and some physiological alarms are pre-set by the system and cannot be changed by the user in most of the cases. But you can alter the alarm level for **SpO₂ SENSOR OFF**. For more information, please refer to *SpO₂ SETUP* in 4.10 *Maintain*.

5.1.2 Alarm Modes

When alarm occurs, the monitor can raise the user's attention in at least three ways, which are audio prompt, visual prompt and description.

Audio and visual prompt is given by LCD display device, the speaker on the display device and the alarm indicator. Physiological alarm, Technical Alarm or description is displayed in Information area at the bottom of the screen.

NOTE:



The concrete presentation of each alarm prompt is related to the alarm level.

Screen Display

When the measured parameter exceeds its alarm limits and triggers a physiological alarm, the monitor will give alarm prompt on the screen indicating the occurrence of alarm.

The description will display in Information area, such as “** NS TOO HIGH”, and  displays beside the parameter to indicate the low-medium level alarm.

Technical alarm will not prompts “*” signal.

Alarm Level	Visual Prompt
High	1:  displays in Parameter area 2: *** displays beside the parameter (Physiological alarm only)
Medium	1:  displays in Parameter area 2: ** displays beside the parameter (Physiological alarm only)
Low	1:  displays in Parameter area 2: * displays beside the parameter (Physiological alarm only)

Lamp light

The high/medium/low-level alarms are indicated by the system in following different visual ways:

Alarm Level	Visual Prompt
High	Alarm indicator flashes in red with high frequency.
Medium	Alarm indicator flashes in orange with low frequency.
Low	Alarm indicator lights on in orange.

Alarm Sound

The high/medium/low-level alarms are indicated by the system in following different audio ways:

Alarm Level	Audio Prompt
High	Mode is “beep-beep-beep-----beep-beep, beep-beep-beep---beep-beep”, which is triggered once every 5 seconds.
Medium	Mode is “beep-beep-beep”, which is triggered once every 20 seconds.
Low	Mode is “beep-”, which is triggered once every 25 seconds.

The sound pressure range for audible alarm signals is from 45 dB to 85 dB.

WARNING

Do not rely exclusively on the audible alarm system for patient monitoring. Adjustment of alarm volume to a low level or off during patient monitoring may result in patient danger. Remember that the most reliable method of patient monitoring combines close personal surveillance with correct operation of monitoring equipment.

NOTE:

- 1 When alarms of different levels occur at the same time, the monitor prompts the one of the highest level.
- 2 If the monitor is powered off and then turned on, the alarm setup can resume to the setup which is set before the power-off.

5.1.3 Alarm Setup

Setup alarm in the ALARM SETUP menu

Select the **ALARM SETUP** in the **SYSTEM MENU** to open the submenu. In this menu, the user may turn **ON** or **OFF** the alarm, and set the upper alarm limit and lower alarm limit for each parameter by **ALM HI** or **ALM LO**.

Alarm setup of each parameter

In the **ALARM SETUP** menu, select the item to set the alarm limit for **EtCO₂**, **FiCO₂**, **AWRR**, **SpO₂** and **PR**.

For example: Method to set alarm limit for **SpO₂ ALM**:

Step 1: Set the **SpO₂ ALM** to **ON**;

Step 2: Select the **ALM HI** (higher limit of **SpO₂ ALM**), **ALM LO** (lower limit of **SpO₂ ALM**).

You can use the **UP/DOWN** button and **OK** button to make the set the value.

The method for setting the alarm limit of other parameters is the same as **SpO₂ ALM**.

ALM REC and ALM REC TIME

By configuring **ALM REC**, the function of automatically outputting the alarm information in case of any physiological alarm can be enabled or disabled. If the item is **ON**, the monitor will automatically print out the alarm information once any physiological alarm happens. If the item is **OFF**, the monitor will not automatically output the alarm information.

Additionally, if **ALM REC** is set to **ON**, you can also adjust the recording time of the alarm waveform to be outputted by setting **ALM REC TIME**. Available options are **8 s**, **16 s** and **32 s**.

ARLAM RESET

Selecting **ARLAM RESET** in **ALARM SETUP**, the function of resetting alarm can be enabled.

After the alarm is reset, the monitor will stop auditory alarm including physiological alarm and

technical alarm; the visual alarm indications are still displayed in information area; auditory alarm will prompt if a new alarm occurs.

5.2 Alarm Cause

Alarm occurs when:

1. Physiological alarm is evoked;
2. Alarm for error of the system (technical alarm) is evoked.

■ A. Conditions that activate the parameter alarms:



The measurement value exceeds the alarm limit and the alarm is set to **ON**. Alarms will not activate if the alarm is set to **OFF**.

■ B. Conditions that activate the system alarms (technical alarm):

Upon the system error, the monitor prompts alarm immediately.

5.3 Audio Alarm Paused

To activate the audio alarm off function, you can select **SYSTEM MENU > MAINTAIN > USER MAINTAIN > OTHER SETUP > ALARM SETUP**, and set **AUDIO ALARM PAUSED** to **60 S**, **120 S** or **180 S** (The default duration of auditory alarm pause is 120 S), then press the button  on the front panel. During the audio alarm paused status:

- ◆ In the information area, the monitor displays audio alarm off icon  and **AUDIO PAUSED XXXS** with a yellow background.
- ◆ The button  on the front panel always flashes.
- ◆ The audio alarm is turned off, and no alarms are sounding.
- ◆ The visual alarm indications are still displayed.
- ◆ Other audible signals are not affected, including beat volume, key volume.

Auditory alarm will resume when you press the button  again or the pause time terminates.

When **AUDIO ALARM PAUSED** is set to **OFF**, this function is inactivated. The monitor has no response if you press the button .



NOTE:

If a new alarm occurs during the audio alarm paused status, the new alarm will not be sounding.

5.4 Audio Alarm Off

To activate the audio alarm off function, you can select **SYSTEM MENU > MAINTAIN > USER MAINTAIN > OTHER SETUP > ALARM SETUP**, and set **AUDIO ALARM OFF** to

ON, then press the button  on the front panel and hold it for more than three seconds to turn off audio alarm. During the audio alarm off status,

- ◆ In the information area, the monitor displays the audio alarm off icon  and **AUDIO ALARM OFF** with a red background.
- ◆ The button  on the front panel flashes in yellow, with frequency of (0.5~1) Hz.
- ◆ The audio alarm is turned off, and no alarms are sounding.
- ◆ The visual alarm indications are still displayed.
- ◆ Other audible signals are not affected, including beat volume, key volume.

Pressing the button  again can resume the audio alarm.

When **AUDIO ALARM OFF** is set to **OFF**, this function is inactivated. The monitor has no response if you press and hold the button  for more than three seconds.

NOTE:

If a new alarm occurs during the audio alarm off period, the new alarm will not be sounding.

5.5 Alarm Reset

To reset the alarm, please select **SYSTEM MENU > ALARM SETUP > ALARM RESET**. After resetting the alarm,

- ◆ The audio alarm is turned off, and no alarms are sounding.
- ◆ The visual alarm indications are still displayed.
- ◆ It will not influence the configuration of physiological alarm off, audio alarm paused and audio alarm off status.

NOTE:

If a new alarm occurs after the alarm is reset, the new alarm will be sounding.

5.6 Parameter Alarm

WARNING

- 1 Prior to monitoring, make sure that the alarm limit settings are appropriate for your patient.
 - 2 Setting alarm limits to extreme values may cause the alarm system to become ineffective.
-

The setup for parameter alarms is in their menus. In the menu for a specific parameter, you can check and set the alarm limit, alarm status. The setup is isolated from each other.

When a parameter alarm is off, a symbol  displays near the parameter. If the alarms are turned off individually, they must be turned on individually.

For the parameters whose alarm is set to **ON**, the alarm will be triggered when at least one of them exceeds alarm limit. The following actions take place:

1. Alarm message displays on the screen as described in alarm mode;
2. The monitor beeps in its corresponding alarm class and volume;
3. Alarm lamp flashes.

5.7 When an Alarm Occurs

NOTE:

When an alarm occurs, you should always check the patient's condition first.

The alarm message appears at the top of the screen on the right side. It is needed to identify the alarm and act appropriately, according to the cause of the alarm.

1. Check the patient's condition.
2. Identify the cause of the alarm.
3. Identify which parameter is alarming or which alarm is happening.
4. When cause of alarm has been over, check that the alarm is working properly.

You will find the alarm messages for the individual parameter in their appropriate parameter chapters of this manual.

5.8 Testing Alarms

When you switch the monitor on, a self-test is started. The monitor will prompt a “Di” tone that means the audio in self test is normal. Meantime, you must check that the alarm indicator lights are normal. For further testing of individual measurement alarms, perform the measurement on yourself or use a simulator. Adjust alarm limits and check that appropriate alarm behavior is observed.

Chapter 6 Trend and Recording

The monitor provides 72-hour trend data of all parameters (**EtCO₂**, **FiCO₂**, **AwRR**, **SpO₂** and **PR**), 5-hour CO₂ waveform, 5-hour SpO₂ waveform and 800 alarm events.

In **SELECTION** submenu, the user can set the displayed table, then the trend table or alarm list which can be printed out via **RECORD** button.

6.1 General Information on Recording

A thermal dot matrices recorder with 48 mm wide printout paper is used for the monitor.

Performance of the Recorder:

- Trend list is printed out at the rate of 25 mm/s.
- English printout.

Set the displayed content via **SELECTION** in **SYSTEM MENU** (Refer to *4.4 Selection*), then print it via **RECORD** button.

If you need to print the former data, you can shift the displayed table by **UP/DOWN** button, and then the former data can be displayed and printed out.

The real-time waveform of 8 s can be printed out.

NOTE:

- 1 You can press the **RECORD** button on the control panel to stop the current recording process.
- 2 It is suggested that user should not use the recorder when the low battery displays, or the monitor may be turned off automatically.

6.2 Recorder Operations

Record Paper Requirement

Only standard thermosensitive record paper can be used, otherwise the recorder may not function, the recording quality may be poor, and the thermosensitive print head may be damaged.

Proper Operation

- When the recorder is working, the record paper goes out steadily. Do not pull the paper outward with force; otherwise the recorder may be damaged.
- Do not operate the recorder without record paper.

Paper Out

When **RECORDER OUT OF PAPER** alarm is displayed, the recorder cannot start. Please insert record paper properly.

Inserting Paper

- Pull outwards the upper arc part of the recorder casing to release the casing.
- Insert a new roll of paper into the paper cassette, printing side facing upwards.
- Ensure proper position and tidy margin.
- Pull about 2 cm of the paper out, and then close the recorder casing.

NOTE:

Be careful when inserting paper. Avoid damaging the thermo-sensitive print head. Unless when inserting paper or shooting troubles, do not leave the recorder catch open.

Removing Paper Jam

When the recorder functions or sounds improperly, you should open the recorder casing to check for a paper jam. Removing the paper jam in the following way:

- Cut the record paper from the feeding edge.
- Open the recorder casing.
- Re-insert the paper.

6.3 Recorder Alarm Information

Technical Alarm:

Message	Cause	Alarm Level	What to do
Recorder Out Of Paper	Recorder Out Of Paper	Low	Please install the paper
No Recorder	The user presses the RECORD button when Recorder is not configured.	Low	Notify the manufacturer's service staff to install and set the recorder.

Chapter 7 Maintenance/Cleaning

WARNING

- 1 Failure on the part of the responsible individual hospital or institution employing the use of this equipment to implement a satisfactory maintenance schedule may cause undue equipment failure and possible health hazards.
- 2 If you discover a problem with any of the equipment, contact your service personnel, or your authorized supplier.
- 3 The maintenance operations like software upgrade of the device can only be completed by EDAN's qualified service professionals.

7.1 Inspecting

The overall check of the monitor, including the safety check, should be performed only by qualified personnel every 24 months, and each time after fix up.

The following items should be checked:

- If the environment condition and power supply meet requirement.
- If the power supply cord has damage and insulativity meets requirement.
- If the device and accessories have damage.
- Specified accessories.
- If the alarm system can work properly.
- If the recorder can work properly and the paper meets the requirement.
- Battery performance
- If all monitoring functions are in good conditions.
- If the grounding resistance and leakage current meet requirement.

If any damage or abnormality is found, please don't use the monitor and contact local Customer Service Center.

7.2 Maintenance Task and Test Schedule

Maintenance shall be carried out at least once every two years, or as specified by local regulations. The following tasks are for EDAN-qualified service professionals only. Contact an EDAN-qualified service provider if your monitor needs a safety or performance test. Clean and disinfect equipment to decontaminate it before testing or maintaining it.

Maintenance and Test Schedule	Frequency
Safety checks. Selected tests on the basis of IEC60601-1	At least once every two years, or as needed, after any repairs where the power supply is removed or replaced, or if the monitor has been dropped.

Maintenance and Test Schedule	Frequency
Check all monitoring functions and measuring functions	At least once every two years, or as needed.

7.3 Cleaning

If the device or accessory has been in contact with the patient, then cleaning and disinfection is required after every use. If there has been no patient contact and there is no visible contamination then daily cleaning and disinfection is appropriate.

The validated cleaning agents for cleaning the monitor and reusable accessories are:

- Mild near neutral detergent
- Ethanol (75%)
- Isopropanol (70%)

Cleaning agents should be applied and removed using a clean, soft, non-abrasive cloth or paper towel.

7.3.1 Cleaning the Monitor

WARNING

Before cleaning the monitor, make sure that the monitor is switched off and disconnected from the power line.

To surface-clean the monitor, follow these steps:

1. Switch off the monitor and disconnect it from the power line.
2. Wipe the entire exterior surface, including the screen, of the equipment using a soft cloth dampened with the cleaning solution thoroughly until no visible contaminants remain.
3. After cleaning, wipe off the cleaning solution with a fresh cloth or towel dampened with tap water until no visible cleaning agent remains.
4. Dry the monitor in a ventilated and cool place.

7.3.2 Cleaning the Reusable Accessories

7.3.2.1 Cleaning the SpO₂ Sensor

1. Wipe the surfaces of the sensor and cable using a soft cloth dampened with the cleaning solution until no visible contaminants remain.
2. Wipe the patient contact area of the sensor with the cotton swab dampened with the cleaning solution. until no visible contaminants remain
3. Wipe off the cleaning solution with a fresh cloth or towel, dampened with tap water after cleaning until no visible cleaning agent remains.

4. Wipe off residual moisture with a dry cloth.
5. Leave the sensor to air dry.

7.4 Disinfection

For devices or accessories that have been in contact mucosal surface, High Level disinfection must occur, for all other accessories, low level disinfection is appropriate. Clean the monitor and reusable accessories before they are disinfected. The validated disinfectants for cleaning the monitor and reusable accessories are:

- Ethanol (75%)
- Isopropanol (70%)
- Cidex OPA (High level disinfection of intracavitary temperature probe only)

If Ethanol or Isopropanol is used for both cleaning and disinfecting, then a new cloth is required to be used for the disinfection step.

WARNING

The monitor and reusable accessories shall be disinfected to avoid patient cross infection.

CAUTION

- 1 Do not use any disinfectant containing additional active ingredients other than those listed, such as disinfectant didecyl dimethyl ammonium bromide which contains quaternary ammonium salt.
 - 2 Although the monitor chemically resistant to most common hospital cleaners, disinfectants and non-caustic detergents, different cleaners or disinfectants are not recommended and may stain the monitor, such as disinfectant didecyl dimethyl ammonium bromide which contains quaternary ammonium salt.
-
-

7.4.1 Disinfecting the Monitor

WARNING

Before disinfecting the monitor, make sure that the monitor is switched off and disconnected from the power line.

To disinfect the monitor, follow these steps:

1. Switch off the monitor and disconnect it from the power line.
2. Wipe the display screen using a soft, clean cloth dampened with the disinfectant solution.
3. Wipe the exterior surface of the equipment using a soft cloth dampened with the disinfectant solution.

4. Wipe off the disinfectant solution with a dry cloth after disinfection if necessary.
5. Dry the monitor for at least 30 minutes in a ventilated and cool place.

7.4.2 Disinfecting the Reusable Accessories

7.4.2.1 Disinfecting the SpO₂ Sensor

1. Wipe the surfaces of the sensor and cable using a soft cloth dampened with the disinfection solution.
2. Wipe the patient contact area of the sensor with the cotton swab dampened with the disinfection solution.
3. Wipe off the disinfection solution with a dry cloth after disinfection.
4. Leave the sensor to air dry for at least 30 minutes.

7.5 Cleaning and Disinfecting Other Accessories

For cleaning and disinfecting other accessories, refer to the instructions delivered with the accessories. If the accessories are not accompanied by instructions, refer to this manual for the methods of cleaning and disinfecting the monitor.

7.6 Replacement of Fuse

Unscrew the fuse cap anticlockwise, replace the fuse (protector tube) and screw down the fuse cap clockwise. Fuse size: $\Phi 5 \times 20$, Rated value: T2.0 AH250VP.

NOTE:

Switch off the power of the monitor before examining the fuse.

7.7 Cleaning Battery and Battery Compartment Cover

Use only non-caustic detergents such as soap and warm water (40 °C/104 °F maximum) to clean the battery. Do not use strong solvent to clean battery, and do not dip the battery in liquid.

Chapter 8 SpO₂ Monitoring

8.1 Overview

SpO₂ is used to measure arterial blood oxygen saturation, which is the percentage of oxyhemoglobin in the arterial blood. SpO₂ parameter can also provide pulse rate (PR) and a plethysmogram wave (Pleth).

8.2 SpO₂ Safety Information

WARNING

- 1 Do not use the SpO₂ sensors if the packaging or the sensor is damaged and return them to the vendor.
 - 2 If the SpO₂ sensor cannot work properly, please reconnect the sensor or change a new one.
 - 3 Correct and proper sensor application: if the sensor is too loose, it might compromise the optical alignment, and even cause the sensor to fall off. If the sensor is too tight, (such as the application site is too large or becomes too large due to edema), excessive pressure and local tissue ischemia, hypoxia and lack of nutrition may occur on the application site. Prolonged and continuous monitoring may increase the risk of Skin irritations or lacerations. To avoid these damages, users should periodically check surrounding skin of application site according to the patient's condition and pressure sensor, inspect the if there is sign of stress-related damage in surrounding tissue, and regularly change the application site. For the patients whose fluid is easy to transfer and/or the patients with systemic or localized edema, users should inspect the skin and change application site more frequently.
 - 4 Use only EDAN permitted sensors and extension cables with the monitor. Other sensors or extension cables may cause improper monitor performance and/or minor personal injury.
 - 5 High oxygen levels may predispose a premature infant to retrolental fibroplasia. If this is a consideration do NOT set the high alarm limit to 100%, which is equivalent to switching the high limit alarm off.
 - 6 When serious arrhythmia is present, the SpO₂ pulse rate may differ from ECG heart rate but this does not indicate an inaccurate PR (SpO₂) value.
-
-

NOTE:

- 1 Avoid placing the sensor on extremities with an arterial catheter, or intravascular venous infusion line.
- 2 When a trend toward patient deoxygenation is indicated, analyze the blood samples with a laboratory co-oximeter to completely understand the patient's condition.

- 3 SpO₂ waveform is not directly proportional to the pulse volume.
- 4 The device is calibrated to display functional oxygen saturation.
- 5 A Functional tester or simulator cannot be used to assess the SpO₂ accuracy. However, it can be used to demonstrate that a particular monitor reproduces a calibration curve that has been independently demonstrated to meet a particular accuracy.
- 6 If the surrounding temperature increases, the operator should pay attention to the site of poor perfusion, and increase the frequency of checking the skin and changing the measurement site to prevent burns. If the initial skin temperature is less than 35°C, the temperature of all the listed sensors on the skin will not exceed 41°C during working.
- 7 The cumulative use time for the single-patient SpO₂ sensor in a single patient should be less than 30 days.

8.3 Measuring SpO₂

1. Select the correct patient category setting (adult/pediatric and neonatal), as this is used to optimize the calculation of the SpO₂ and pulse numeric.
2. During measurement, ensure that the application site:
 - has a pulsatile flow, ideally with a good circulation perfusion.
 - has not changed in its thickness, causing an improper fit of the sensor.

Measurement Procedure

1. Switch on the monitor.
2. Attach the sensor to the appropriate site of the patient finger.
3. Plug the connector of the sensor extension cable into the SpO₂ socket on the SpO₂ module.

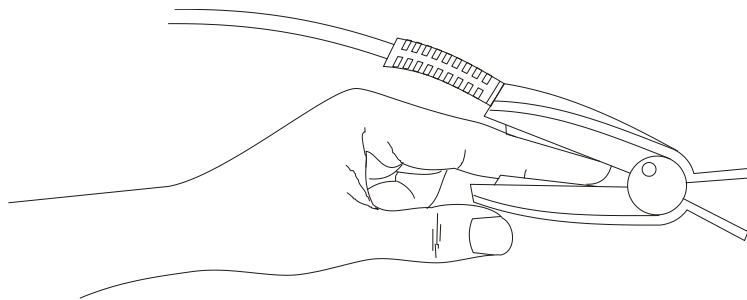

Mounting of the Sensor

WARNING

Inspect the application site every two to three hours to ensure skin quality and correct optical alignment. If the skin quality changes, move the sensor to another site. Change the application site at least every four hours. For neonate, change the measuring site every 20 minutes.

NOTE:

- 1 Injected dyes such as methylene blue or intravascular dyshemoglobins such as methemoglobin and carboxyhemoglobin may lead to inaccurate measurements.
- 2 Inspect the sensor to ensure that the light emitter and receiver are aligned with each other and there is no gap between the sensor and the finger. All the light emitted by the light emitter must pass through the patient's tissue. The sensor cable should be placed on the back of the hand.
- 3 Clean and remove any substances such as nail polish from the application site. Periodically check to ensure that the sensor remains properly positioned on the patient.

8.4 Measurement Limitations

Certain patient conditions can affect the measurements and cause the loss of the pulse signal.

Inaccurate measurements can be caused but not limited by:

- incorrect sensor application
- high levels of ambient light sources, such as surgical lights (especially those with a xenon light source), bilirubin lamps, fluorescent lights, infrared heating lamps, and direct sunlight
- failure to cover the sensor with opaque material in high levels of ambient light conditions
- dysfunctional hemoglobins
- low peripheral perfusion
- excessive or violent patient movement
- venous pulsations
- intravascular dyes, such as indocyanine green or methylene blue
- externally applied coloring agents (nail polish, dye, pigmented cream)
- defibrillation
- placement of the sensor on an extremity with a blood pressure cuff, arterial catheter, or intravascular line
- electromagnetic interference

Loss of pulse signal can occur for the following reasons:

- the sensor is applied too tightly
- a blood pressure cuff is inflated on the same extremity as the one with the sensor attached
- there is arterial occlusion proximal to the sensor
- low peripheral perfusion

NOTE:

- 1 To prevent interference from ambient light, ensure that the sensor is properly applied, and cover the sensor site with opaque material.

- 2 Adjacent SpO₂ sensors may interfere with each other (eg, multiple SpO₂ measurements in the same patient). Be sure to cover the sensor with opaque material to reduce cross-interference.
- 3 Move the sensor to a less active site, and keep the patient still, if possible.
- 4 For Nellcor SpO₂ module, the algorithm automatically extends the amount of data required for measuring SpO₂ and PR depending on the measurement conditions. During normal measurement conditions the averaging time is 6 to 7 seconds. During conditions such as those caused by low perfusion, interference (e.g., external interference such as ambient light or patient movement), or a combination of these, the algorithm automatically extends the amount of data required beyond 7 seconds. If the resulting dynamic averaging time exceeds 20 seconds, the screen will display prompt message “Search Pulse” and SpO₂ and PR will continue to be updated every second. As these conditions extend, the amount of data required continues to increase. If the dynamic averaging time reaches 40 seconds, the screen will display high-level alarm message “No Pulse” indicating a loss-of-pulse condition.

8.5 Assessing the Validity of a SpO₂ Reading

You can check the quality of the pleth wave and the stability of the SpO₂ values to assess whether the sensor functions properly and whether the SpO₂ readings are valid. Always use these two indications simultaneously to assess the validity of a SpO₂ reading.

Generally, the quality of the SpO₂ pleth wave reflects the quality of the light signals obtained by the sensor. A wave of poor quality manifests a decline of the signal validity. On the other hand, the stability of the SpO₂ values also reflects the signal quality. Different from varying SpO₂ readings caused by physiological factors, unstable SpO₂ readings are resulted from the sensor's receiving signals with interference. The problems mentioned above may be caused by patient movement, wrong sensor placement or sensor malfunction. To obtain valid SpO₂ readings, try to limit patient movement, check the placement of the sensor, measure another site or replace the sensor.

NOTE:

- 1 The SpO₂ accuracy has been validated in controlled human studies against arterial blood sample reference measured with a CO-oximeter. SpO₂ measurements are statistically distributed, only about two-thirds of the measurements can be expected to fall within the specified accuracy compared to CO-oximeter measurements. The volunteer population in the studies composed of healthy men and women from age 19 to 37 (for EDAN SpO₂ module), from 18 to 50 (for Nellcor SpO₂ module), with various skin pigmentations. Note that the study population was healthy adults and not in the actual intended use population.
- 2 The pulse rate accuracy is obtained by comparison to the pulse rate generated with an arterial oxygen simulator (also an electronic pulse simulator).
- 3 During monitoring, if the monitor's reading differs significantly from the patient's physiological condition, it indicates that the signal may be disturbed, resulting in an

inaccurate reading. In this case, the artifact can disguise as a similar reading, causing the monitor to fail to send an alarm. In order to ensure reliable monitoring, it is necessary to regularly check whether the sensor is wearing properly and the signal quality is good.

8.6 SpO₂ Alarm Delay

There is a delay between a physiological event at the measurement site and the corresponding alarm at the monitor. This delay has two components:

1. The time between the occurrence of the physiological event and when this event is represented by the displayed numerical values. This delay depends on the algorithmic processing time and the sensitivity. The lower the sensitivity configured, the longer the time needed until the numerical values reflect the physiological event.
2. The time between the displayed numerical values exceeding an alarm limit and the alarm indication on the monitor. This delay is the combination of the configured alarm delay time plus the general system delay time.

8.7 Perfusion Index (PI)*

*** Only applicable to the EDAN SpO₂ module.**

PI is a numeric value indicating perfusion level. It reflects the perfusion level at the monitoring site.

As the measurement of SpO₂ is based on the pulsation caused by the blood flow through the vessel, PI is in relation to the strength of the pulse. Also, you can use PI as a signal quality indicator for the measurement of SpO₂.

PI is indicated by a value ranging from 0 to 10. The bigger the value is, the better the perfusion and the signal quality will be. The perfusion level and the signal quality are at their maximum when the value reaches 10. When PI is below 2, it indicates the low perfusion and the poor signal quality at the monitoring site; you need to reposition the sensor or find a better site.

The PI value will be displayed on the SpO₂ waveform area.

8.8 SatSeconds Alarm Management*

*** Only applicable to the Nellcor SpO₂ module. Not applicable to MFM-CMS**

8.8.1 Describing SatSeconds

With traditional alarm management, upper and lower alarm limits are set for monitoring oxygen saturation. During monitoring, as soon as an alarm limit is violated by as little as one percentage point, an alarm is immediately triggered. When the SpO₂ level fluctuates near an alarm limit, the alarm is triggered each time the limit is violated. Such frequent alarms can be distracting.

With the SatSeconds technique, upper and lower SpO₂ alarm limits are set in the same way as traditional alarm management. However, you can also set a SatSeconds limit that allows monitoring of SpO₂ below the selected lower alarm limit and above the selected upper alarm limit for a period of time before an alarm is triggered.

The method of calculation is as follows:

The number of percentage points that the SpO₂ falls outside the alarm limit is multiplied by the number of seconds that the SpO₂ level remains outside that limit. This can be stated as an equation:

$$\text{Points} \times \text{Seconds} = \text{SatSeconds}$$

Where:

Points = SpO₂ percentage points outside of the limit

Seconds = number of seconds that SpO₂ remains at that point outside of the limit

The alarm response time, assuming a SatSeconds limit set at 50 and a lower alarm limit set at 90, is described and illustrated below.

In this example, the SpO₂ level drops to 88 (2 points below the limit) and remains there for a period of 2 seconds (2 points \times 2 seconds = 4 SatSeconds). The SpO₂ then drops to 86 for 3 seconds and then to 84 for 6 seconds. The resulting SatSeconds values are shown below:

SpO ₂		Seconds		SatSeconds
2	\times	2	=	4
4	\times	3	=	12
6	\times	6	=	36
Total SatSeconds			=	52

After approximately 10.7 seconds, a SatSeconds alarm will be triggered, because the limit of 50 SatSeconds has been exceeded. See arrow (\uparrow) in the following figure.

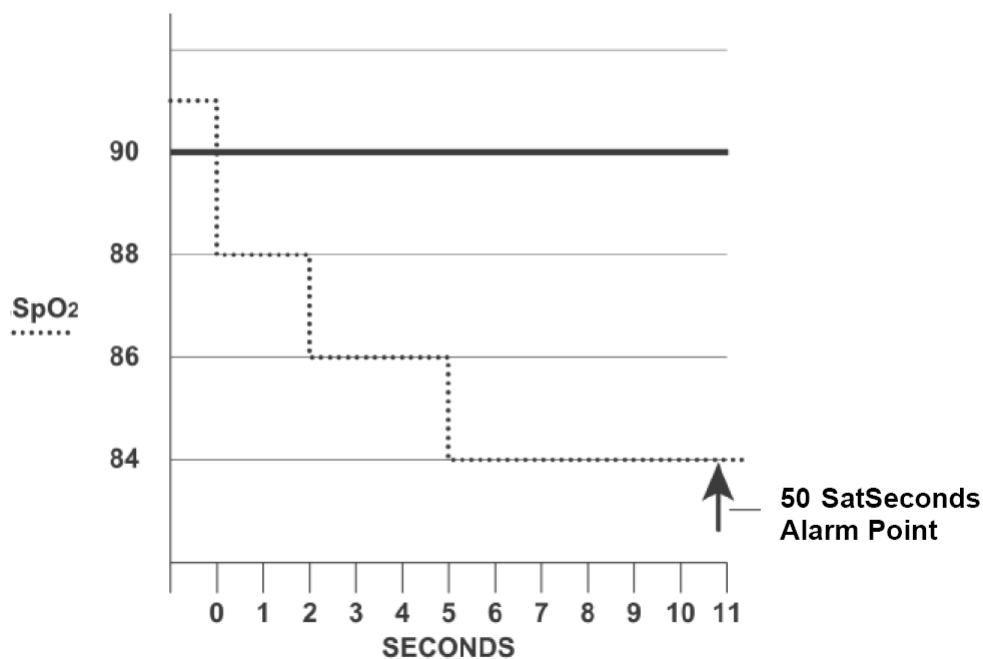

Alarm Response with SatSeconds

Saturation levels may fluctuate rather than remaining steady for a period of several seconds.

Often, the patient SpO₂ may fluctuate above and below the alarm limit, re-entering the non-alarm range several times. During such fluctuation, the monitor integrates the number of SpO₂ points, both positive and negative, until either the SatSeconds limit is reached, or the patient SpO₂ returns within a normal range and remains there.

8.8.2 SatSeconds “Safety Net”

The SatSeconds “Safety Net” is for patients whose saturation makes frequent excursions below or above the SpO₂ limit but does not remain in violation long enough for the SatSeconds limit to be reached. If three or more SpO₂ alarm limit violations occur within a 60-second period, an alarm will be triggered even if the SatSeconds limit has not been reached.

8.8.3 Setting SatSeconds Duration

You can set **SatSeconds** to **Off** or to the duration among **10**, **25**, **50** and **100**. To configure the SatSeconds settings, enter the **SpO₂ Setup** menu and select the desired SatSeconds setting from the **SatSeconds** list.

8.9 Alarm Setup Menu

Enter **SYSTEM MENU > ALARM SETUP**:

In the menu, the alarm for SpO₂ or PR can be turned **ON** or **OFF**, and the alarm limits can be adjusted. Select **ON** to enable alarm during SpO₂ monitoring; select **OFF** to disable the alarm function, and a  will be displayed on the screen beside the corresponding parameter.

Enter **SYSTEM MENU > ALARM SETUP**:

In the menu, the alarm for SpO₂ or PR can be turned **ON** or **OFF**, and the alarm limits can be adjusted. Select **ON** to enable alarm during SpO₂ monitoring; select **OFF** to disable the alarm function, and a  will be displayed on the screen beside the corresponding parameter.

WARNING

In order to avoid endangering the patient’s life, the user should use this function cautiously.

Default SpO₂ alarm limits:

	Max. Upper Limit	Min. Lower Limit	Step
ADU	100	90	1
PED	100	90	1
NEO	95	88	1

Default PR alarm limits:

	Max. Upper Limit	Min. Lower Limit	Step
ADU	120	50	1

	Max. Upper Limit	Min. Lower Limit	Step
PED	160	75	1
NEO	200	100	1

SpO₂/ PR adjustable range of alarm limits:

SpO₂/ PR adjustable range of alarm limits:

	Adjustable Range
SpO ₂	0~100
PR	30~300

8.10 Alarm Description

SpO₂ Alarm Message

Tables below describe the possible physiological alarms, technical alarms occurring during SpO₂ measurement.

When there is no SpO₂ or PR input, it prompts weak signal.

Physiological alarm:

Message	Cause	Alarm Level
SpO₂ TOO HIGH	SpO ₂ measuring value is above upper alarm limit.	Medium
SpO₂ TOO LOW	SpO ₂ measuring value is below lower alarm limit.	Medium
PR TOO HIGH	PR measuring value is above upper alarm limit.	Medium
PR TOO LOW	PR measuring value is below lower alarm limit.	Medium
NO PULSE	The signal of the measurement site is too weak due to insufficient blood supply and environmental factors, so the monitor can't detect the pulse signal.	High

Technical alarms:

Message	Cause	Alarm Level	What to do
SpO₂ SENSOR OFF	The SpO ₂ sensor may be disconnected from the patient.	Low	Make sure the sensor is attached to the patient's finger or another appropriate position.

Message	Cause	Alarm Level	What to do
SpO₂ STOP COMM	SpO ₂ module failure or communication failure	High	Stop using measuring function of SpO ₂ module; notify biomedical engineer or manufacturer's service staff.
SpO₂ LOW PERFUSION	The measured signals coming from pulse are too weak or the pressure on measured site is too low.	Low	Reconnect the sensor, or choose another measured position. If the problem remains, please notify biomedical engineer or manufacturer's service staff.
NO SpO₂ SENSOR	The SpO ₂ sensor is disconnected from the monitor, or the sensor is not connected well to the device.	Low	Reconnect the sensor with the monitor. Make sure the monitor is well connected with the cable.
SpO₂ Sensor Err.	Malfunction in the SpO ₂ sensor or in the extension cable.	Low	Replace the SpO ₂ sensor or the extension cable.
SpO₂ Interference	Ambient light around the sensor is too strong.	Low	Reduce interference of the ambient light and avoid sensor's exposure to strong light.
SpO₂ NOISY SIGNAL	There is interference with SpO ₂ measurement signals due to patient movement, ambient light, electrical interference or else.	Low	Check the condition of patient and avoid patient movement; make sure the cable is well connected.

Prompts:

Message	Cause
SEARCH PULSE	SpO ₂ sensor may be disconnected from the patient or the monitor.
SpO₂ NOISY SIGNAL	There is interference with SpO ₂ measurement signals due to patient movement, ambient light, electrical interference or else. (Nellcor)

Chapter 9 CO₂ Monitoring

9.1 Overview

The monitor provides the sidestream and mainstream methods for CO₂ monitoring. Respironics Sidestream CO₂ module are used for sidestream measuring, and Respironics Mainstream CO₂ module is used for mainstream measuring.

The principle of CO₂ measurement is primarily based on the fact that CO₂ molecule can absorb 4.3 μm infrared ray. Absorption intensity is proportional to CO₂ concentration of patient sample, the CO₂ concentration will compute according to the detecting CO₂ absorption intensity of patient sample.

√ SideStream measurement takes a sample of the respiratory gas with a constant sample flow from the patient's airway and analyzes it with a remote CO₂ sensor. You can measure sidestream CO₂ using the monitor's built-in CO₂ measurement. Respiration rate is calculated by measuring the time interval between detected breaths.

√ MainStream measurement uses a CO₂ sensor attached to an airway adapter to directly insert into the patient's breathing system. This method is available using the monitor's built-in CO₂ measurement.

9.2 CO₂ Safety Information

WARNING

- 1 Do not use the device in the environment with flammable anesthetic gas.
 - 2 The device should be used by trained and qualified medical personnel authorized by EDAN.
 - 3 Nitrous oxide, elevated levels of oxygen, helium, xenon, halogenated hydrocarbons, and barometric pressure can influence the CO₂ measurement.
 - 4 The monitor will be damaged if any pipeline from the CO₂ module's air tube /the air inlet /the air outlet is plugged by water or other materials.
 - 5 The accuracy of the CO₂ measurement will be affected by the following reasons: the airway was highly obstructed; the leakage of air way connection or quick variation of environment temperature.
 - 6 Follow precautions for electrostatic discharge (ESD) and electromagnetic interference (EMI) to and from other equipment.
 - 7 Do not place the sensor cables or tubing in any manner that may cause entanglement or strangulation.
 - 8 When using mechanical ventilation, gas compensation should be well set. Inappropriate setting may cause incorrect measurement result.
-
-

WARNING

- 9 Respironics module is not equipped with automatic air pressure compensation, before you start the CO₂ measurement for the first time, you must set the correct altitude. Incorrect altitude settings can cause incorrect CO₂ readings.
 - 10 Leakage in the respiratory system or sampling system may result in a significant low display of the EtCO₂ value. Always keep all components connected firmly and check for leaks according to standard clinical procedures.
 - 11 The EtCO₂ reading is not always closely related to the paCO₂ value, especially in neonatal patients, and patients with pulmonary disease, with pulmonary embolism or inappropriate ventilation.
 - 12 Don't measure CO₂ while nebulized medications are being delivered.
 - 13 The CO₂ module temporarily stops measuring during zeroing.
-
-

NOTE:

- 1 After the low battery alarm appears, please do not start the CO₂ measurement, or the monitor may turn off for the low capacity of battery.
- 2 For disposal of hospital waste such as accumulated fluids, calibration gases, sampled gases, where not otherwise specified, follow local regulations regarding disposal of hospital waste.
- 3 If the measurement or sensor fails, stop measurement before the qualified service personnel solves the problem.

9.3 Monitoring Procedures

9.3.1 Zeroing the Sensor

For the Respironics Sidestream CO₂ Module:

1. Connect the sample line to the module correctly, wait until the monitor's warm-up message disappears, and keep the inlet of sample line away from CO₂ source.
2. In the **CO₂ Setup** menu, set **Work Mode** to **Measure**.
3. Select **Zero Calibration** in **CO₂ Setup** menu.
4. After the zeroing calibration is completed, the zeroing message disappears, and the CO₂ monitoring can be performed. If the monitor displays **Breath Detected** or **Zero Required**, zeroing has failed. Zero calibration must be performed again.

For the Respironics Mainstream CO₂ Module:

1. Wait until the monitor's warm-up message disappears; correctly install the mainstream CO₂ sensor to airway adaptor and remove it from breathing circuit, keep the monitor away from CO₂ source.

2. In the **CO₂ Setup** menu, set **Work Mode** to **Measure**.
3. Select **Zero Calibration** in **CO₂ Setup** menu.
4. After the zeroing calibration is completed, the zeroing message disappears, and the CO₂ monitoring can be performed. If the monitor displays **Breath Detected** or **Zero Required**, zeroing has failed. Zero calibration must be performed again.

Note: CO₂ source includes ventilator, patient's and operator's breath.

9.3.2 Sidestream CO₂ Module

For the Respironics Sidestream CO₂ Module:

1. Plug the sensor cable into the CO₂ input connector on the sidestream CO₂ module. Allow the sensor two minutes for warm-up.
2. Connect the cannula, airway adapter, or sample line as required to the sensor. It will click into place when seated correctly.
3. To zero the sensor, please refer to zeroing the sensor.
4. For intubated patients, an airway adapter is required.

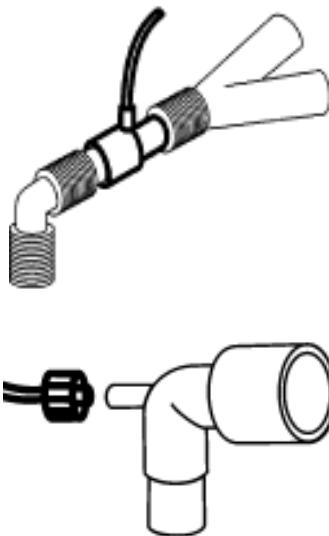

Air Adapter

For non-intubated patients: Place the nasal cannula onto the patient.



Place the Nasal Cannula

NOTE:

- 1 You must perform a zero calibration as described in this procedure each time the ambient temperature changes more than 10 °C (for example during transport).
- 2 Always connect the airway adapter to the sensor before inserting the airway adapter into the breathing circuit. In reverse, always remove the airway adapter from the breathing circuit before removing the sensor.
- 3 Disconnect the cannula, airway adapter or sample line from the sensor when they are not in use.
- 4 To extend the lifetime of the module, set **Work Mode** to **Standby** when the module is not in use.
- 5 The sidestream CO₂ module continuously extracts a quantity of gas from the patient's airway per minute. Please do not use this module in any patient who will be affected by this sampling rate.
- 6 If the catheter falls off during the measurement, it is necessary to re-zero after the catheter is well connected, and then measurement can be performed.

Removing Exhaust Gases from the System

WARNING

Do not connect the exhaust tube to the ventilator circuit, connect the outlet to a scavenging system, cross infection can occur if sampling gas is returned to the breathing system. When using the sidestream CO₂ measurement on patients who are receiving or have recently received anesthetics, please avoid exposing medical staff to anesthetics.

Use an exhaust tube to remove the sample gas to a scavenging system. Attach it to the sidestream sensor at the outlet connector.

9.3.3 Mainstream CO₂ Module

NOTE:

You must perform a zero calibration as described in this procedure each time you use a new airway adapter.

9.3.3.1 Measurement Steps

- 1 Attach the sensor connector to the CO₂ connector on the mainstream CO₂ module.
- 2 Wait two minutes, allowing the sensor to reach its operating temperature and a stable thermal condition.
- 3 Choose the appropriate airway adapter and connect it to the sensor head. The airway adapter clicks into place when seated correctly.

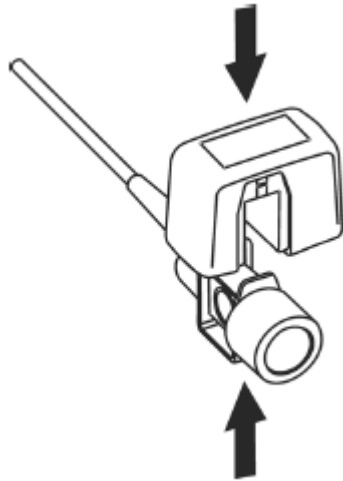

Connecting Sensor

- 4 To zero the sensor, please refer to Chapter zeroing the sensor;
- 5 Install the airway adapter at the proximal end of the circuit between the elbow and the ventilator Y-section.

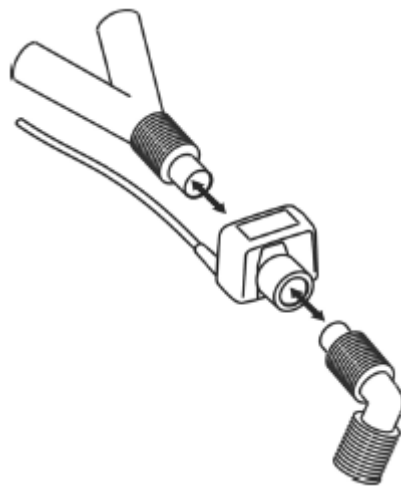

Connecting Airway Adapter

WARNING

- 1 No routine user calibration is required.
 - 2 Accuracy is affected by temperature and barometric pressure.
-

NOTE:

- 1 If the catheter falls off during the measurement, it is necessary to re-zero after the catheter is well connected, and then measurement can be performed.
- 2 Replace the airway adapter, if excessive moisture or secretions are observed in the tubing or if the CO₂ waveform changes unexpectedly without a change in patient status.
- 3 To avoid cross infection, use only disinfected or disposable airway adapters.

- 4 Inspect the airway adapters prior to use. Do not use it if airway adapter appears damaged or broken. Observe airway adapter color coding for patient population.
- 5 Periodically check the flow sensor and tubing for excessive moisture or secretion buildup.
- 6 Always connect the airway adapter to the sensor before inserting the airway adapter into the breathing circuit. In reverse, always remove the airway adapter from the breathing circuit before removing the sensor.
- 7 To avoid dead space, place the sensor as close to the patient as possible.

9.4 CO₂ Setup Menu

9.4.1 CO₂ Setup

Select **CO₂ SETUP** in **SYSTEM MENU** to setup CO₂.

Now we introduce the functions of each item in **CO₂ SETUP** submenu.

- **WAVE SCALE**: Adjust full scale size of CO₂ waveform display area with **LOW** or **HIGH** selectable. The default value is **LOW**.
- **BARO PRESS**: set the barometric pressure value. For gaining accurate readings, you should set this barometric pressure correctly.
- **O₂ COMPENS**: to adjust the O₂ compensating concentration as per the selection of the user. Input the proper O₂ compensating value according to the O₂ concentration of the inhaled gas.
- **ANE AGENT**: to adjust the anesthetic compensating concentration as per the selection of the user. The concentration ranges from 0~20%. Input the proper concentration value according to the anesthetic gas concentration of the inhaled gas.
- **BALAN GAS**: to balance the gas compensating operations. Select the different compensating types for balancing gas. The compensate types are **ROOM AIR**, **N₂O** and **HELIUM**.
- **APNEA ALM**: After selecting the alarm time for **APNEA** alarm (having 7 levels, which are **10 S**, **15 S**, **20 S**, **25 S**, **30 S**, **35 S** and **40 S**), the **CO₂ APNEA** information will appear on the screen after the corresponding selected time. The alarm level is **HIGH**.
- **ZERO CAL**: used to perform CO₂ model zero calibration.

When a dramatic change in CO₂ measurement or the accuracy of reading is suspected by the clinician, the zero calibration should be operated.

First the CO₂ module should be taken off from the patient, then press the **CO₂ START/STOP** button, select **ZERO CAL** item, then the system will automatically inhale clean CO₂-free room air to the air inlet of CO₂ module beside the monitor, and start zero calibration.

NOTE:

- 1 The standard barometric pressure is 760 mmHg, O₂ concentration is about 16%. The **BARO PRESS** should be set according to local altitude, refer to table 9-1 for details.

- 2 If the **ANE AGENT**, **O₂ COMPENS**, **BALAN GAS** are set incorrectly, the measure readings will be seriously remote the reality, leads to wrong diagnosis.
- 3 The **ZERO CAL** needs about 20 seconds. During this period, you'd better not do other operation, such as respiration measuring. Or the zero calibration will be fail, and you should do calibration operation again.

9.4.2 CO₂ Alarm Setup

Select **ALARM SETUP** in **SYSTEM MENU**.

The items to be set in the menu include:

- **EtCO₂ ALM/ FiCO₂ ALM/ AWRR ALM**: Select **ON** to enable and store alarm prompt when CO₂ parameters have alarms. Select **OFF** to disable alarm and display  beside CO₂. The default is **ON**.

WARNING

In order to avoid endangering the patient's life, the user should use this function cautiously.

- **EtCO₂ ALM HI**: to adjust the upper alarm limit of EtCO₂. If the measuring value is larger than CO₂ upper alarm limit, **CO₂ TOO HIGH** appears in the Information area. After the measuring value returns to the normal one, the information disappears.
- **EtCO₂ ALM LO**: to adjust the lower alarm limit of EtCO₂. If the measuring value is smaller than CO₂ lower alarm limit, **CO₂ TOO LOW** appears in the Information area. After the measuring value returns to the normal one, the information disappears.
- **FiCO₂ ALM HI**: to adjust the upper alarm limit of FiCO₂. If the measuring value is larger than FiCO₂ upper alarm limit, **FiCO₂ TOO HIGH** appears in the Information area. After the measuring value returns to the normal one, the information disappears.
- **AWR ALM HI**: to adjust the upper alarm limit of AwRR. If the measuring value is larger than the upper alarm limit of AwRR, **AWRR TOO HIGH** appears in the Information area. After the measuring value returns to the normal one, the information disappears.
- **AWR ALM LO**: to adjust the lower alarm limit of AwRR. If the measuring value is smaller than the lower alarm limit of AwRR, **AWRR TOO LOW** appears in the Information area. After the measuring value returns to the normal one, the information disappears.

The default value for each items are as follows:

CO₂ ALM HI: when EtCO₂ value exceeds this limit, there will be alarm for exceeding the upper limit.

Default:

Adult: 50 mmHg

Pediatric: 50 mmHg

Neonatal: 45 mmHg

CO₂ ALM LO: when EtCO₂ value is smaller than the lower limit, there will be alarm for exceeding lower limit.

Default:

Adult: 15 mmHg

Pediatric: 20 mmHg

Neonatal: 30 mmHg

AWRR ALM HI: when parameter value exceeds this limit, there will be alarm for exceeding upper limit.

Default:

Adult: 30 rpm

Pediatric: 30 rpm

Neonatal: 100 rpm

AWRR ALM LO: when parameter value is smaller than the limit, there will be alarm for exceeding lower limit.

Default:

Adult: 8 rpm

Pediatric: 8 rpm

Neonatal: 30 rpm

FiCO₂ ALM HI: when parameter value exceeds this limit, there will be alarm for exceeding upper limit.

Default:

Adult: 4 mmHg

Pediatric: 4 mmHg

Neonatal: 4 mmHg

WAVE SCALE: LOW/HIGH

Default: LOW

WAVEFORM: FILLED/UNFILLED

Default: UNFILLED

BARO PRESS: (400 ~ 850) mmHg

Default: 760 mmHg

O₂ COMPENS: 0% ~ 100%

Default: 16%

ANE AGENT: 0% ~ 20%

Default: 0.0%

BALAN GAS: ROOM AIR/N₂O/HELIUM

Default: ROOM AIR

APNEA ALM: Selections are 10 s to 40 s

Default: 20 s

9.4.3 Adjustable Range of Alarm Limits

CO₂ alarm limits are listed as follows:

	Adjustable Range
EtCO ₂	0 mmHg~150 mmHg
FiCO ₂	High limit: 0 mmHg~50 mmHg
AwRR	2 rpm~150 rpm

9.5 Alarm Information and Prompt

Tables below describe the possible physiological alarms, technical alarms and prompt messages occurring during CO₂ measurement.

Physiological alarms:

Message	Cause	Alarm Level
CO₂ APNEA	In specific time interval, no breath can be detected using CO ₂ module.	High
CO₂ TOO HIGH	EtCO ₂ measuring value is above upper alarm limit.	Medium
CO₂ TOO LOW	EtCO ₂ measuring value is below lower alarm limit.	Medium
FiCO₂ TOO HIGH	FiCO ₂ measuring value is above alarm limits.	Medium
AWRR TOO HIGH	AwRR measuring value is above upper alarm limit.	Medium
AWRR TOO LOW	AwRR measuring value is below lower alarm limit.	Medium

Technical alarms:

Message	Cause	Alarm Level	Remedy
CO₂ ROM ERR	CO ₂ module failure	High	Stop using measuring function of CO ₂ module; notify biomedical engineer or Manufacturer's service staff.
CO₂ COMM STOP	CO ₂ module failure or communication failure	High	
CO₂ INT RAM ERR	CO ₂ module failure	High	
CO₂ SENSOR FAULT	CO ₂ module failure	Medium	

Message	Cause	Alarm Level	Remedy
CO₂ ADAPTER OCCULED	Check if the adapter is well connected or occluded.	High	Well connect the adapter again; check if the adapter is occluded.
CHECK ADAPTER		Low	
ZERO REQUIRED	The module need to be zero calibrated.	Low	Zero the CO ₂ module.

Prompt message:

Message	Cause
CO₂ STANDBY STATUS	Turn from measuring mode to standby mode, making the module in energy-saving status.
CO₂ SENSOR TEMP HIGH	The temperature of CO ₂ sensor is too high.
CO₂ SENSOR TEMP LOW	The temperature of CO ₂ sensor is too low.
CO₂ WARM UP	The CO ₂ module is at warm-up state.

Chapter 10 Other Functions

10.1 Nurse Call

The monitor provides dedicated nurse call port which is connected to nurse call system through the nurse call cable to perform the nurse call function.

10.2 Network

The monitor can be connected with PC through network port. Also, the monitor can construct wireless network with router. Our company arranges the qualified engineers to install and set the wired or wireless network for the user and test the corresponding performance. For details, please refer to *Patient Monitor Wireless Network Installation Guide*.

NOTE:

- 1 Be aware that some network-based functions may be limited for monitors on wireless networks in comparison with those on wired networks.
- 2 The obstacle may interfere with data transmission and even cause data loss.
- 3 Use the wireless device recommended by EDAN, otherwise some exceptional situations such as frequent network disconnection may occur on the monitor.
- 4 When signal intensity is unstable, the quality of the signal transmission may be degraded.
- 5 For detailed specifications of router, please refer to the router's user guide.
- 6 When the monitor is connected to MFM-CMS via the wireless network, the user should set the router to a secure encryption/authentication mode (Recommended option: WPA2-PSK, with a high complexity, non-dictionary password).

10.3 Central Monitoring System

The monitor can be connected to the central monitoring system. Through the network:

1. The monitor sends patient information, real-time monitoring or measurement data to the central monitoring system.
2. The real-time monitoring information is displayed on the central monitoring system as the same to the monitor, and the central monitoring system can perform some bilateral control. For example: changing patient information, receiving patient, discharging patient and so on.
3. The alarm information of bed side monitor is displayed on the central monitoring system For example: audio alarm paused, audio alarm off and physiological alarm status and so on.

For detailed information, please refer to *MFM-CMS Central Monitoring System User Manual*.

NOTE:

- 1 MFM-CMS can display max 12 bits barcode.
- 2 Make sure the **Free Online Mode** in CMS is turned on when the barcode is more than 12 bits, and then the monitor can display the real barcode.
- 3 When deploying the network of the monitor and MFM-CMS, it is recommended to isolate the network and the Intranet system of the hospital by using VLAN so as to ensure the network security.

Chapter 11 Accessories

You can order accessories from EDAN supplies at www.edan.com.cn or consult your local Edan representative for details.

WARNING

- 1 Never reuse disposable transducers, sensors, accessories and their casing that are intended for single use; or only use them on a single patient. Reuse may compromise device functionality and system performance and cause a potential hazard.
- 2 Use only EDAN-approved accessories. Using non-EDAN-approved accessories may compromise device functionality and system performance and cause a potential hazard. It is not recommended to use accessories supplied by EDAN with patient monitors by other manufacturers.
- 3 Do not use a sterilized accessory if its casing is damaged.

NOTE:

Transducers and sensors have a limited shelf life. Refer to the package labeling.

The following cables may not all be available in all countries. Please check availability with your local EDAN supplier.

The following accessories are recommended when using this monitor.

SpO₂	
02.01.109069	SpO ₂ Finger Sensor, adult, 2.5 m, reusable
02.01.109079	SpO ₂ Finger Sensor, adult, 1m, reusable
01.13.210001	SpO ₂ adapter cable, standard (Lemo to DB9)
02.01.110492	SpO ₂ Warp Sensor, Neonate, 1 m, reusable
02.01.110515	SpO ₂ Silicone Soft-tip Sensor, adult, 1 m, reusable
02.01.110521	SpO ₂ Silicone Soft-tip Sensor, pediatric, 1 m, reusable
01.57.471235	SHD-A SpO ₂ Sensor, adult, disposable
01.57.471237	SHD-I SpO ₂ Sensor, Infant, disposable
01.57.471236	SHD-P SpO ₂ Sensor, pediatric, disposable
01.57.471238	SHD-N SpO ₂ Sensor, Neonate, disposable
01.15.30043	Nellcor Reusable Adult SpO ₂ Sensor (DS-100A OxiMax)

01.15.40096	Nellcor Reusable Adult/Neonate SpO ₂ Sensor (OXI-A/N OxiMax)
CO₂	
02.08.078137	Respironics EtCO ₂ module/(Side-stream) 1022054
02.08.078166	LoFlo™ Module Mounting Bracket (Respironics 1027730)
01.57.078139	Disposable CO ₂ Nasal Cannula - Adult (Respironics 3468ADU-00)
01.57.078140	Disposable CO ₂ Nasal Cannula - Pediatric (Respironics 3468PED-00)
01.57.078141	Disposable CO ₂ Nasal Cannula - Infant (Respironics 3468INF-00)
01.57.078154	Disposable Sampling Line Kit with Dehumidification Tubing (Respironics 3475-00)
01.15.040143	Respironics CAPNOSTAT 5 EtCO ₂ (Main-stream) Module 1015928
01.59.078155	CO ₂ Airway Adapter, Adult, disposable (6063-00)
01.59.078156	CO ₂ Airway Adapter, Neonatal (infant/pediatric) (6312-00)
01.57.078142	Adult Nasal CO ₂ with O ₂ delivery sampling cannula (Respironics 3469ADU-00)
01.57.078143	Pediatric Nasal CO ₂ with O ₂ delivery sampling cannula (Respironics 3469PED-00)
01.57.078144	Infant Nasal CO ₂ with O ₂ delivery sampling cannula (Respironics 3469INF-00)
01.57.101019	Adult Nasal/Oral CO ₂ sampling cannula (Respironics 3470ADU-00)
01.57.101020	Pediatric Nasal/Oral CO ₂ sampling cannula (Respironics 3470PED-00)
01.57.101021	Adult Nasal/Oral CO ₂ with O ₂ delivery sampling cannula (Respironics 3471ADU-00)
01.12.031598	Adult/Pediatric Airway adapter kit (Respironics 3472ADU-00)
01.57.078151	Adult/Pediatric Airway adapter kit with dehumidification tubing (Respironics 3473ADU-00)
01.57.078152	Pediatric/Infant Airway adapter kit with dehumidification tubing (Respironics 3473INF-00)
01.57.078158	Pediatric mask/mainstream 9960PED-00

01.57.078159	Adult standard mask /mainstream 9960STD-00
01.57.078160	Adult large mask /mainstream 9960STD-00
01.57.078161	Band/mainstream 8751-00
01.12.078162	Card Slot /Mainstream 6934-00
Others	
01.57.78035	Printing paper
02.01.109481	Wall hanger
02.01.109592	Pole Clamp /1 piece
02.01.109636	Pole Clamp /4 pieces
01.13.36014	Power cable (EUR standard) 220 V
01.13.036667	Power cable (USA standard)
01.21.064142	Rechargeable Lithium-Ion Battery/ TWSLB-002 (14.8 V, 2500 mAh)
01.21.064143	Rechargeable Lithium-Ion Battery/ TWSLB-003 (14.8 V, 5000 mAh)
01.13.114114	Grounded cable
02.01.101207	Wireless AP
01.18.052245	Netac USB flash disk (U208, 4G, USB2.0)
01.23.068003	USB barcode scanner (Cipher LAB 1000U, USB port, contact, CCD scan)
01.56.466104	M3 series portable bag
02.04.241690	Patient monitor mounting arm assembly kit (Big basket)
83.60.261116	MT-206 Trolley (Plastic wheels)
83.60.261069	MT-206 Trolley (Metal wheels)
02.04.101976	Rolling Stand Basket (in the bottom)
02.04.243472	Patient monitor mounting arm assembly kit (Small basket)

NOTE:

The part name may vary depending on context, but the part number is constant.

Chapter 12 Warranty and Service

12.1 Warranty

EDAN warrants that EDAN's products meet the labeled specifications of the products and will be free from defects in materials and workmanship that occur within warranty period.

The warranty is void in cases of:

- a) Damage caused by mishandling during shipping.
- b) Subsequent damage caused by improper use or maintenance.
- c) Damage caused by alteration or repair by anyone not authorized by EDAN.
- d) Damage caused by accidents.
- e) Replacement or removal of serial number label and manufacture label.

If a product covered by this warranty is determined to be defective because of defective materials, components, or workmanship, and the warranty claim is made within the warranty period, EDAN will, at its discretion, repair or replace the defective part(s) free of charge. EDAN will not provide a substitute product for use when the defective product is being repaired.

12.2 Contact Information

If you have any question about maintenance, technical specifications or malfunctions of devices, contact your local distributor.

Alternatively, you can send an email to EDAN service department at: support@edan.com.cn.

Appendix A Specifications

A.1 Classification

Anti-electroshock type	Class I equipment and internal powered equipment
Anti-electroshock degree	SpO ₂ , CO ₂ BF
Ingress Protection	IPX1
Working system	Continuous operation equipment
Compliant with Safety Standards	IEC 60601-1: 2005+A1:2012; IEC 60601-1-2:2014; EN 60601-1: 2006+A1:2013; EN 60601-1-2: 2015; ISO 80601-2-61: 2011; ISO 80601-2-55: 2011; IEC 60601-2-49: 2011

A.2 Specifications

NOTE:

The performance of the equipment with ☆ mark is determined to be essential performance.

A.2.1 Size and Weight

Size	(174±2) mm (W) ×(235±2) mm (H)×(189±2) mm (D)
Weight	≤ 3.5 kg (not including battery)

A.2.2 Function Configuration

Model	Standard Function	Optional Function
M3B	SpO ₂ , CO ₂	/

A.2.3 Environment

The monitor may not meet the performance specifications given here if stored or used outside the specified temperature and humidity ranges.

When the monitor and related products have differing environmental specifications, the effective range for the combined products is that range which is common to the specifications for all products.

Temperature	
Working	0 °C ~+40 °C (32 °F ~104 °F)
Transport and Storage	-20 °C ~+55 °C (-4 °F ~131 °F)
Humidity	
Working	15% RH~95% RH (non-condensing)
Transport and Storage	15% RH ~ 95% RH (non-condensing)
Altitude	
Working	86 kPa ~ 106 kPa
Transport and Storage	70 kPa ~ 106 kPa
Power Supply	100 V-240 V~, 50 Hz/60 Hz, Pmax=70 VA, FUSE T2.0 AH250 VP

A.2.4 Display

Device	5.6-inch LCD, Multicolor LCD resolution: 640×480
Messages	1 Power Indicator LED (Green)
	1 Power on Indicator LED (Green)
	1 Alarm Indicator LED (Orange/ Red)
	1 Charge Indicator LED (Yellow)
	1 Alarm Sound Indicator LED (Backlight)
	1 CO ₂ Working Status Indicator LED (Backlight)
	3 Indicating modes correspond to alarm mode
NURSE CALL	
Drive mode	Relay
Electronic	≤ 1 A, ≤ AC125 V, ≤ DC110 V
Isolated voltage	1500 V AC
Action	Normal open

A.2.5 Battery

Quantity	1
Type	Li battery
Power-off delay	5 min ~ 15 min (After the low battery alarm)

Voltage	14.8 V DC
Capacitance	2500 mAh /5000 mAh
Working period At (25±2) °C, continuous SpO ₂ measuring, automatic recording per 10 min	
Typical Working Period	2500 mAh: 7 h; 5000 mAh: 14 h
Maximum Rechargeable Period	2500 mAh: 3.5 h; 5000 mAh: 7 h
	(The monitor is on or in standby mode.)

A.2.6 Recorder

Record Width	48 mm
Paper Speed	12.5 mm/s, 25 mm/s
Recording types	Current displayed parameter list recording
	Current displayed alarm list recording
	Real-time 8s waveform recording
	Recording of all the parameter of current patient ID

A.2.7 Review

Trend List Recall	72 h, 1 Min. Resolution
Alarm List Recall	800 groups

A.2.8 SpO₂

☆ Measuring Range	0% ~100%
☆ Adjustable Range of Alarm Limits	0% ~100%
Resolution	1%
☆ Accuracy	
Adult /Pediatric	±2% (70%~100% SpO ₂)
	Undefined (0%~69% SpO ₂)
Neonate	±3% (70%~100% SpO ₂)
	Undefined (0%~69% SpO ₂)
☆ Accuracy	±2 bpm
☆ Data update period	1 s

PI		
Measuring Range	0~10. It displays 0 for invalid PI value.	
Resolution	1	
Wave length		
Red light	(660±3) nm	
Infrared light	(905±10) nm	
Emitted light energy	<15 mW	
Nellcor Module		
☆Measuring Range	1% ~ 100%	
☆Adjustable Range of Alarm Limits	0% ~ 100%	
Resolution	1%	
Data update period	1s	
☆Accuracy	DS-100A, OXI-A/N (Adult):	±3% (70% ~100% SpO ₂)
	OXI-A/N (Neonate):	±4% (70% ~ 100% SpO ₂)
Sensor	Wave length: approximately 660 nm and 900 nm	
	Emitted light energy: <15 mW	

NOTE:

The information about wavelength range can be especially useful to clinicians (for instance, when photodynamic therapy is performed).

A.2.9 PR

		☆Measuring range	☆Accuracy	Resolution
PR (SpO ₂)	EDAN	25 bpm to 300 bpm	±2 bpm	1 bpm
	Nellcor	20 bpm to 300 bpm	±3 bpm (20 bpm to 250 bpm)	1 bpm
PR (NIBP)	EDAN	40 bpm to 240 bpm	±3 bpm or 3.5%, whichever is greater	1 bpm

A.2.10 CO₂

Applicable Patient Type	Adult, pediatric and neonatal patients
Technique	Infra-red Absorption Technique
Unit	mmHg, %, Kpa

☆Measuring Range	
EtCO ₂	0 mmHg ~150 mmHg
FiCO ₂	3 mmHg ~50 mmHg
AwRR	0 rpm ~150 rpm (Mainstream) 2 rpm ~150 rpm (Sidestream)
Resolution	EtCO ₂ 1 mmHg
	FiCO ₂ 1 mmHg
	AwRR 1 rpm
☆EtCO ₂ Accuracy	± 2 mmHg, 0 to 40 mmHg
	±5% of reading, (41 ~70) mmHg
	±8% of reading, (71 ~100) mmHg
	±10% of reading, (101~150) mmHg
	±12% of reading, RR is over 80 rpm (Sidestream) There will be no degradation in performance due to Respiration Rate. (mainstream)
AwRR Accuracy	±1 rpm
Sample Gas Flowrate	(50 ±10) ml/min
O ₂ Compensation	
Range	0% ~100%
Resolution	1%
Default	16%
Stability	
Short Term Drift	Drift over 4 hours < 0.8 mmHg
Long Term Drift	120 h
Initialization time	It displays the value within 15s and meets the requirement for measurement accuracy within 2 min. (Mainstream)
	It displays the value within 20 s and meets the requirement for measurement accuracy within 2 min. (Sidestream)
☆Data Sample Rate	100 Hz
☆ CO ₂ Rise Time/Response Time (Mainstream)	< 60 ms
☆ Sensor Response time (Sidestream)	<3 s (including transport time and rise time)
Calibration	Not required.
Barometric pressure	User setup

compensation	
☆Alarm Type	EtCO ₂ , FiCO ₂ , AwRR
☆Apnea Alarm Delay	10 s, 15 s, 20 s, 25 s, 30 s, 35 s, 40 s, 45 s; default value is 20 s.

Interfering Gas and Vapor Effects on EtCO₂ Measurement Values:

Gas or vapor	Gas level (%)	Quantitative effect/Comments
Nitrous oxide	60	Dry and Saturated Gas
Halothane	4	(0 ~ 40) mmHg: ±1 mmHg additional error
Enflurane	5	(41 ~70) mmHg: ±2.5% additional error
Isoflurane	5	(71~100) mmHg: ±4% additional error
Sevoflurane	5	(101~150) mmHg: ±5% additional error
Xenon	80	*Additional worst case error when compensation for P _B , O ₂ , N ₂ O, anesthetic agents, or helium is correctly selected for the actual fractional gas constituents present.
Helium	50	
Desflurane	15	Desflurane: The presence of desflurane in the exhaled breath at concentrations greater than 5% will positively bias Carbon Dioxide values by up to an additional 3 mmHg at 38 mmHg. Xenon: The presence of Xenon in the exhaled breath will negatively bias Carbon Dioxide values by up to an additional 5 mmHg at 38 mmHg.

Barometric Pressure on EtCO₂ Measurement Values:

Quantitative effect
Ambient Barometric, Operational
(0 ~40) mmHg: ±1 mmHg additional error
(41~70) mmHg: ±2.5% additional error
(71 ~100) mmHg: ±4% additional error
(101~150) mmHg: ±5% additional error
*Additional worst case error when compensation for P _B , O ₂ , N ₂ O, anesthetic agents, or helium is correctly selected for the actual fractional gas constituents present.

NOTE:

Respiration Rate accuracy was verified by using a solenoid test setup to deliver a square wave of known CO₂ concentration to the device. 5% and 10% CO₂ concentrations were used. Respiration rate was varied over the range of the device. Pass/Fail criteria was comparison of the respiratory rate output from the sensor to the frequency of the square wave.

Appendix B EMC Information-Guidance and Manufacturer's Declaration

B.1 Electromagnetic Emissions

Guidance and manufacture's declaration – electromagnetic emission		
M3 is intended for use in the electromagnetic environment specified below. The customer or the user of M3B should assure that they are used in such an environment.		
Emission test	Compliance	Electromagnetic environment – guidance
RF emissions CISPR 11	Group 1	M3B uses RF energy only for their internal function. Therefore, their RF emissions are very low and are not likely to cause any interference in nearby electronic equipment.
RF emission CISPR 11	Class A	M3B is suitable for use in all establishments, other than domestic establishments and those directly connected to the public low-voltage power supply network that supplies buildings used for domestic purposes.
Harmonic emissions IEC/EN 61000-3-2	Class A	
Voltage fluctuations/ flicker emissions IEC/EN 61000-3-3	Complies	

NOTE:

The EMISSIONS characteristics of M3B make it suitable for use in industrial areas and hospitals (CISPR 11 class A). If it is used in a residential environment (for which CISPR 11 class B is normally required) M3B might not offer adequate protection to radio-frequency communication services. The user might need to take mitigation measures, such as relocating or re-orienting the equipment.

B.2 Electromagnetic Immunity

Guidance and manufacture's declaration – electromagnetic immunity
M3B is intended for use in the electromagnetic environment specified below. The customer or the user of M3B should assure that they are used in such an environment.

Immunity test	IEC/EN 60601 test level	Compliance level	Electromagnetic environment - guidance
Electrostatic discharge (ESD) IEC/EN 61000-4-2	±8 kV contact ±15 kV air	±8 kV contact ± 15 kV air	Floors should be wood, concrete or ceramic tile. If floor are covered with synthetic material, the relative humidity should be at least 30%.
Electrical fast transient/burst IEC/EN 61000-4-4	±2 kV for power supply lines	±2kV for power supply lines	Mains power quality should be that of a typical commercial or hospital environment.
Surge IEC/EN 61000-4-5	±1 kV for line to line ±2 kV for line to ground	±1 kV for line to line ±2 kV for line to ground	Mains power quality should be that of a typical commercial or hospital environment.
Power frequency (50/60Hz) magnetic field IEC/EN 61000-4-8	30 A/m	30 A/m	Power frequency magnetic fields should be at levels characteristic of a typical location in a typical commercial or hospital environment.
Voltage dips, short interruptions and voltage variations on power supply input lines IEC/EN 61000-4-11	0 % U _T ; 0.5 cycle At 0 °, 45 °, 90 °, 135 °, 180 °, 225 °, 270 ° and 315 ° 0 % U _T ; 1 cycle and 70 % U _T ; 25/30 cycles) Single phase: at 0 ° 0 % U _T ; 250/300 cycle	0 % U _T ; 0.5 cycle At 0 °, 45 °, 90 °, 135 °, 180 °, 225 °, 270 ° and 315 ° 0 % U _T ; 1 cycle and 70 % U _T ; 25/30 cycles) Single phase: at 0 ° 0 % U _T ; 250/300 cycle	Mains power quality should be that of a typical commercial or hospital environment. If the user of M3B requires continued operation during power mains interruptions, it is recommended that M3B be powered from an uninterruptible power supply or a battery.
NOTE U _T is the a.c. mains voltage prior to application of the test level.			

B.3 Electromagnetic Immunity

Guidance and manufacture's declaration – electromagnetic immunity			
M3B is intended for use in the electromagnetic environment specified below. The customer or the user of M3B should assure that they are used in such an environment.			
Immunity test	IEC/EN 60601 test level	Compliance level	Electromagnetic environment - guidance
Conducted RF IEC/EN 61000-4-6 Radiated RF IEC/EN 61000-4-3	3 V _{rms} 150 kHz to 80 MHz 6V _{rms} ^c in ISM bands between 0.15 MHz and 80 MHz 3 V/m 80 MHz to 2.7 GHz See table 1	3 V _{rms} 150 kHz to 80 MHz 6V _{rms} ^c in ISM bands between 0.15 MHz and 80 MHz 3 V/m 80 MHz to 2.7 GHz Comply with table 1	Portable and mobile RF communications equipment should be used no closer to any part of M3B, including cables, than the recommended separation distance calculated from the equation applicable to the frequency of the transmitter. Recommended separation distance $d = 1.2\sqrt{P}$ 150KHz to 80MHz $d = 1.2\sqrt{P}$ 80 MHz to 800 MHz $d = 2.3\sqrt{P}$ 800 MHz to 2.7 GHz $d = 6\sqrt{P}/E$ at RF wireless communications equipment bands (Portable RF communications equipment (including peripherals such as antenna cables and external antennas) should be used no closer than 30 cm (12 inches) to any part of the M3B, including cables specified by the manufacturer). Where P is the maximum output power rating of the transmitter in watts (W) according to the transmitter manufacturer and d is the recommended separation distance in meters (m). Field strengths from fixed RF

			<p>transmitters, as determined by an electromagnetic site survey,^a should be less than the compliance level in each frequency range.^b</p> <p>Interference may occur in the vicinity of equipment marked with the following symbol:</p> 
<p>NOTE 1 At 80 MHz and 800 MHz, the higher frequency range applies.</p> <p>NOTE 2 These guidelines may not apply in all situations. Electromagnetic propagation is affected by absorption and reflection from structures, objects and people.</p>			
<p>^a Field strengths from fixed transmitters, such as base stations for radio (cellular/cordless) telephones and land mobile radios, amateur radio, AM and FM radio broadcast and TV broadcast cannot be predicted theoretically with accuracy. To assess the electromagnetic environment due to fixed RF transmitters, an electromagnetic site survey should be considered. If the measured field strength in the location in which M3B is used exceeds the applicable RF compliance level above, M3B should be observed to verify normal operation. If abnormal performance is observed, additional measures may be necessary, such as reorienting or relocating M3B.</p> <p>^b Over the frequency range 150kHz to 80MHz, field strengths should be less than 3V/m.</p> <p>^c The ISM (industrial, scientific and medical) bands between 0.15 MHz and 80 MHz are 6.765 MHz to 6.795 MHz; 13.553 MHz to 13.567 MHz; 26.957 MHz to 27.283 MHz; and 40.66 MHz to 40.70 MHz. The amateur radio bands between 0.15 MHz and 80 MHz are 1.8 MHz to 2.0 MHz, 3.5 MHz to 4.0 MHz, 5.3 MHz to 5.4 MHz, 7 MHz to 7.3 MHz, 10.1 MHz to 10.15 MHz, 14 MHz to 14.2 MHz, 18.07 MHz to 18.17 MHz, 21.0 MHz to 21.4 MHz, 24.89 MHz to 24.99 MHz, 28.0 MHz to 29.7 MHz and 50.0 MHz to 54.0 MHz.</p>			

Table 1 Test specifications for ENCLOSURE PORT IMMUNITY to RF wireless communications equipment

Test frequency (MHz)	Band ^{a)} (MHz)	Service ^{a)}	Modulation ^{b)}	Maximum power (W)	Distance (m)	Immunity test level (V/m)
385	380-390	TETRA 400	Pulse modulation ^{b)} 18 Hz	1.8	0.3	27
450	430-470	GMRS 460, FRS 460	FM ^{c)} ± 5 kHz deviation 1 kHz sine	2	0.3	28

710	704-787	LTE Band 13, 17	Pulse modulation ^{b)} 217 Hz	0.2	0.3	9
745						
780						
810	800-960	GSM 800/900, TETRA 800, iDEN 820, CDMA 850, LTE Band 5	Pulse modulation ^{b)} 18 Hz	2	0.3	28
870						
930						
1720	1700-1990	GSM 1800; CDMA 1900; GSM 1900; DECT; LTE Band 1, 3, 4, 25; UMTS	Pulse modulation ^{b)} 217 Hz	2	0.3	28
1845						
1970						
2450	2400-2570	Bluetooth, WLAN, 802.11 b/g/n, RFID 2450, LTE Band 7	Pulse modulation ^{b)} 217 Hz	2	0.3	28
5240	5100-5800	WLAN 802.11 a/n	Pulse modulation ^{b)} 217 Hz	0.2	0.3	9
5500						
5785						

NOTE If necessary to achieve the IMMUNITY TEST LEVEL, the distance between the transmitting antenna and the ME EQUIPMENT or ME SYSTEM may be reduced to 1 m. The 1 m test distance is permitted by IEC 61000-4-3.

a) For some services, only the uplink frequencies are included.

b) The carrier shall be modulated using a 50 % duty cycle square wave signal.

c) As an alternative to FM modulation, 50 % pulse modulation at 18 Hz may be used because while it does not represent actual modulation, it would be worst case.

B.4 Recommended Separation Distances

Recommended separation distances between portable and mobile RF communications equipment and M3B			
M3B is intended for use in an electromagnetic environment in which radiated RF disturbances are controlled. The customer or the user of M3B can help prevent electromagnetic interference by maintaining a minimum distance between portable and mobile RF communications equipment (transmitters) and M3B as recommended below, according to the maximum output power of the communications equipment.			
Rated maximum output power of transmitter (W)	Separation distance according to frequency of transmitter(m)		
	150 kHz to 80 MHz $d = 1.2\sqrt{P}$	80 MHz to 800 MHz $d = 1.2\sqrt{P}$	800 MHz to 2.7 GHz $d = 2.3\sqrt{P}$
0.01	0.12	0.12	0.23
0.1	0.38	0.38	0.73
1	1.2	1.2	2.3
10	3.8	3.8	7.3
100	12	12	23
For transmitters rated at a maximum output power not listed above, the recommended separation distance d in meters (m) can be estimated using the equation applicable to the frequency of the transmitter, where P is the maximum output power rating of the transmitter in watts (W) according to the transmitter manufacturer.			
NOTE 1 At 80 MHz and 800 MHz, the separation distance for the higher frequency range applies.			
NOTE 2 These guidelines may not apply in all situations. Electromagnetic propagation is affected by absorption and reflection from structures, objects and people.			

Appendix C Abbreviation

Abbr	English Full Name/Description
AC	Alternating current
Adu	Adult
Art	Arterial
aVF	Left foot augmented lead
aVL	Left arm augmented lead
aVR	Right arm augmented lead
BC	Burst count
BP	Blood pressure
BTPS	Body temperature and pressure, saturated
CCU	Cardiac care unit
CISPR	International Special Committee on Radio Interference
CMS	Central monitoring system
COHb	Carboxyhemoglobin
CVP	Central venous pressure
DC	Direct current
Des	Desflurane
EEC	European Economic Community
EEG	Electroencephalogram
EMC	Electromagnetic compatibility
EMG	Electromyogram
EMI	Electromagnetic interference
Enf	Enflurane
ER	Emergency room
ESU	Electrosurgical unit
EtN ₂ O	End-tidal nitrous oxide
Eto	Ethylene oxide
EtO ₂	End-tidal oxygen
FCC	Federal Communication Commission
FDA	Food and Drug Administration

Abbr	English Full Name/Description
Fi	Fraction of inspired
FiCO ₂	Fraction of inspired carbon dioxide
FiN ₂ O	Fraction of inspired nitrous oxide
FiO ₂	Fraction of inspired oxygen
Hal	Halothane
Hb	Hemoglobin
Hb-CO	Carbon mono-xide hemoglobin
HR	Heart rate
ICP	Intracranial pressure
ICU	Intensive care unit
ID	Identification
IEC	International Electrotechnical Commission
IEEE	Institute of Electrical and Electronic Engineers
Iso	Isoflurane
LA	Left arm
LAP	Left atrial pressure
LCD	Liquid crystal display
LED	Light emitting diode
LL	Left leg
MAP	Mean arterial pressure
MDD	Medical Device Directive
MetHb	Methemoglobin
MRI	Magnetic resonance imaging
N/A	Not applicable
N ₂	Nitrogen
N ₂ O	Nitrous oxide
Neo	Neonate
NICU	Neonatal intensive care unit
NIBP	Non-invasive blood pressure
O ₂	Oxygen
OR	Operating room

Abbr	English Full Name/Description
oxyCRG	Oxygen cardio-respirogram
PA	Pulmonary artery
PACU	Post-anaesthesia care unit
PAWP	Pulmonary artery wedge pressure
Ped	Pediatric
Pleth	Plethysmogram
PR	Pulse rate
PVC	Premature ventricular complex
R	Right
RA	Right arm
RAP	Right atrial pressure
Resp	Respiration
RHb	Reduced hemoglobin
RL	Right leg
RM	Respiration mechanics
RR	Respiration Rate
SEF	Spectral edge frequency
Sev	Sevoflurane
SpO ₂	Pulse Oxygen Saturation
SQI	Signal quality indicator
SR	Suppression ratio
SYS	Systolic pressure
TB	Blood Temperature
TD	Temperature difference
TEMP	Temperature
TP	Total power
USB	Universal serial bus

P/N: 01.54.109451

MPN: 01.54.109451024



EDAN INSTRUMENTS, INC.

#15 Jinhui Road, Jinsha Community, Kengzi Sub-District
Pingshan District, 518122 Shenzhen, P.R.China

Email: info@edan.com.cn

TEL: +86-755-2689 8326 FAX: +86-755-2689 8330

Website: www.edan.com.cn



EC REPRESENTATIVE

Shanghai International Holding Corp. GmbH

Eiffestrasse 80, 20537 Hamburg Germany

TEL: +49-40-2513175

E-mail: shholding@hotmail.com